

DE	Montage Aufdachhalter ADH-W	2
EN	Installation of Roof-Mount Frame ADH-W	5
IT	Montaggio del supporto per fissaggio sul tetto ADH-W	8
ES	Montaje de soporte para tejado ADH-W	11
PT	Montagem de suporte de telhado ADH-W	14
FR	Montage de la Fixation sur toiture ADH-W	17
NL	Montage van Opbouw-dakbeugel ADH-W	20



1 Montage Aufdachhalter ADH-W

Für das Welldach



Sicherheitshinweise beachten

Das dient vor allem dem eigenen Schutz.

- Vor Beginn der Arbeiten mit den Sicherheitshinweisen vertraut machen.
- Die einschlägigen Sicherheitsbestimmungen und geltenden Unfallverhütungsvorschriften beachten und einhalten.
- Zusätzlich gelten die Sicherheitshinweise und weitere Hinweise der bereits vorliegenden Anlagendokumentation.



ACHTUNG

Anleitung beachten

Solvis haftet nicht für Schäden, die durch Nichtbeachten dieser Anleitung entstehen.

- Vor Bedienung oder Installation die Anleitung aufmerksam durchlesen.
- Bei Rückfragen steht der Technische Vertrieb von Solvis zur Verfügung.



Für ergänzende Angaben zu Statik, Abmessungen u. a., siehe → *Montageanleitung zum Kollektor*.



ACHTUNG

Auf festsitzende Verschraubungen achten

- Nach dem Ausrichten der Halteschienen alle Muttern festziehen!

Lieferumfang



Abb. 1: Aufdachhalter ADH-W

- | | |
|-----------------------------|--------------------------|
| 1 Mutter, 6 Stück | 3 Stockschraube, 2 Stück |
| 2 Aluprofil mit Haltewinkel | 4 EPDM-Gummidichtung |

Dachunterkonstruktion



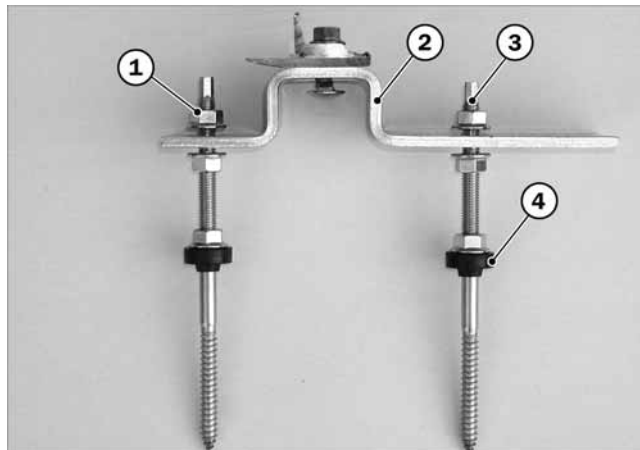

Abb. 2: Lage der Stockschrauben

- | | |
|-----------------------------|--|
| 1 Latte auf Sparren | 4 Stahlträger (nicht erlaubt) |
| 2 Koppellatte auf Sparren | 5 Gekanteter Blechträger (nicht erlaubt) |
| 3 Pfette (mind. 60 x 60 mm) | |

Montage

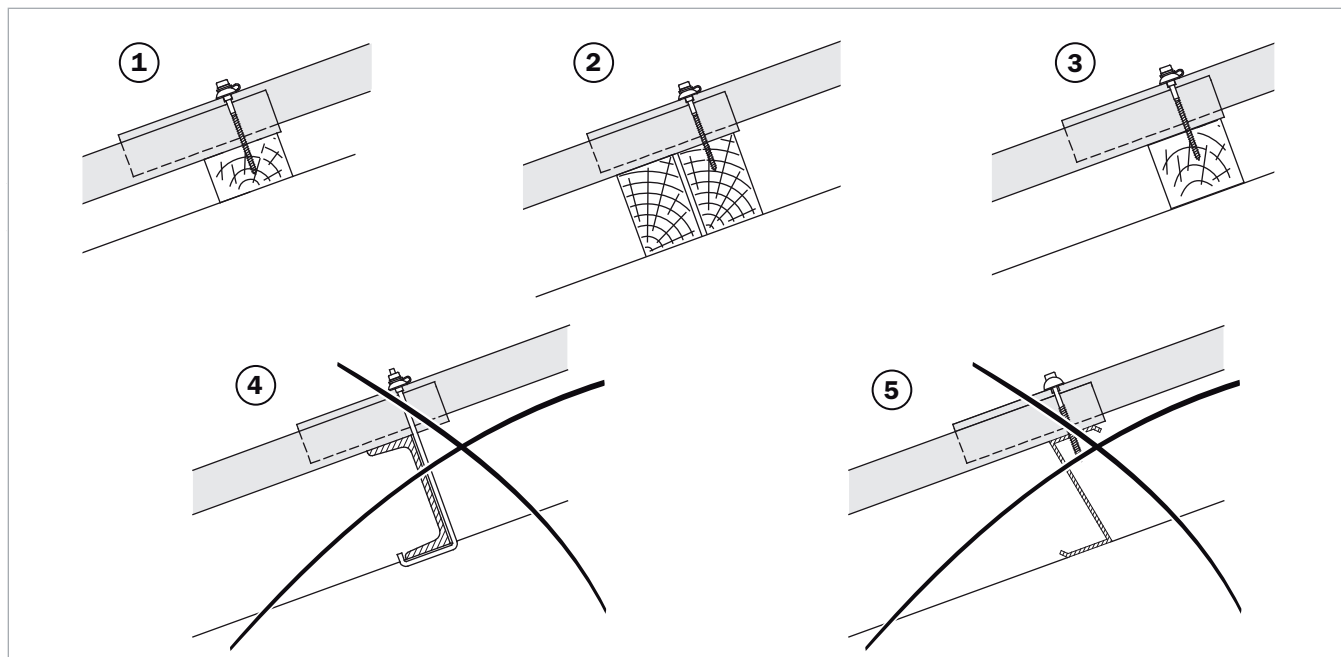
 Für Anzahl und Abstände der Aufdachhalter, siehe → *Montageanleitung zum Kollektor*.



ACHTUNG

Das Holz immer vorbohren

Anderenfalls Rissbildung oder Spaltung möglich.

- In Latte, Pfette oder Sparren: 6 mm Lochdurchmesser
- In Wellplatte Steinbohrer 13 mm verwenden.

Drei Methoden, den Aufdachhalter zu platzieren:

- parallel zum Sparren, beide Schrauben im Sparren
- quer zum Sparren, eine Schraube im Sparren
- quer zum Sparren, Sparren zwischen 2 Schrauben.

Aufdachhalter parallel zum Sparren montieren

1. Methode A: Beide Stockschrauben in den Sparren setzen, dabei EPDM-Dichtung festziehen.



Abb. 3: Beide Stockschrauben im Sparren (Methode A)

- 1 Dichtend festziehen

2. Aluprofil mit Haltewinkel montieren und in der Höhe ausrichten.

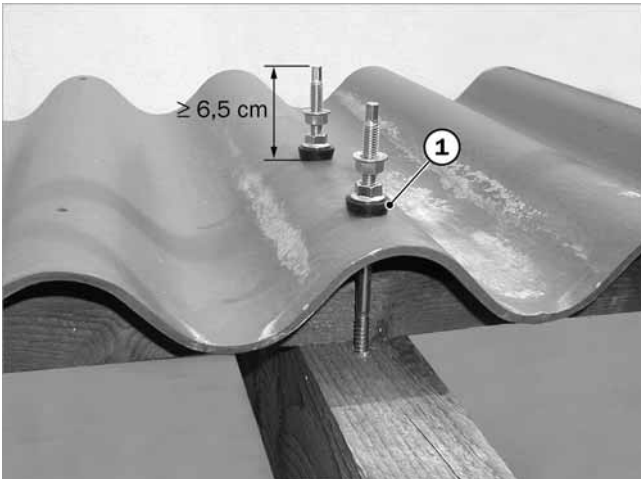

Abb. 4: Aufdachhalter verschraubt (Methode A)

Aufdachhalter quer zum Sparren montieren

1. Stockschrauben setzen, dabei EPDM-Dichtung festziehen. Methode B: eine Schraube in den Sparren und eine daneben.

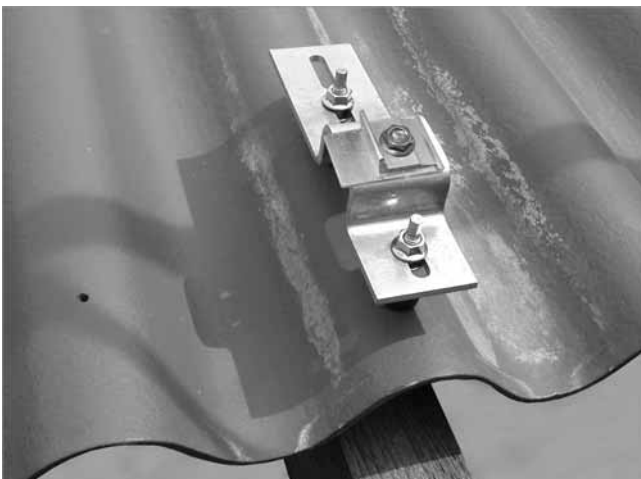

Abb. 5: Schraube 1 x in Sparren, 1 x in Latte (Methode B)

- 1 Dichtend festziehen
- 2 Lage der Schraube → Abb. 8

2. Methode C: beide Stockschrauben so dicht wie möglich neben dem Sparren setzen und Dichtung festziehen.

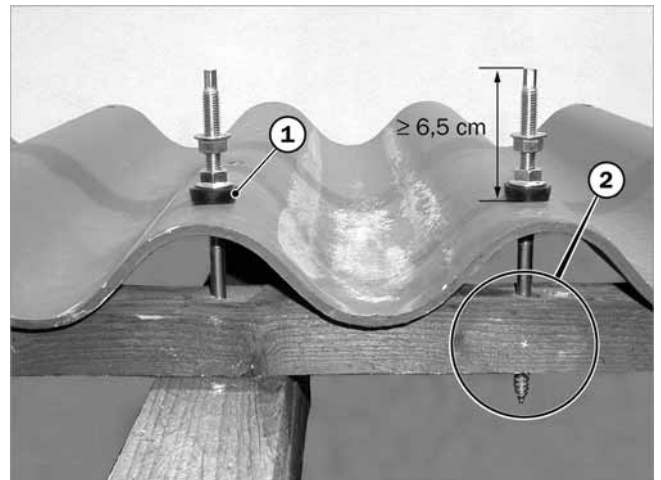

Abb. 6: Schraube 2 x in Latte oder Pfette (Methode C)

- 1 Dichtend festziehen
- 2 Lage der Schraube → Abb. 8

3. Auf keinen Fall beide Stockschrauben so setzen, dass kein Sparren dazwischen ist.

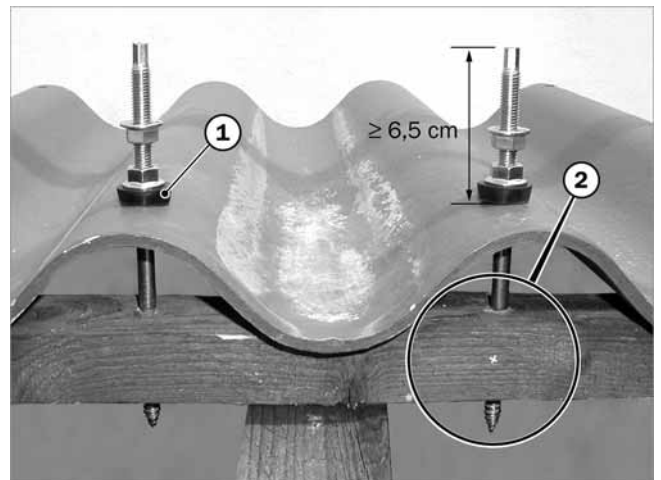

Abb. 7: **Verboten:** Stockschrauben neben Sparren gesetzt



Abb. 9: Aufdachhalter verschraubt (Methode B)

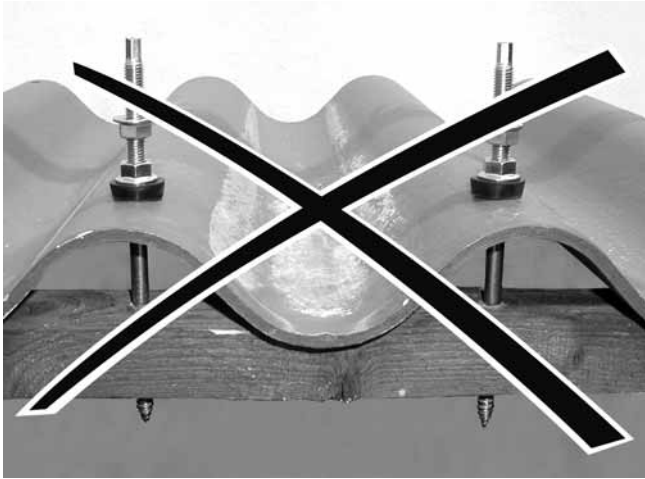

ACHTUNG

Mindesthöhe beachten

Anderenfalls keine ausreichende Tragfähigkeit gewährleistet.

- Das Schraubengewinde muss sich über die gesamte Mindesthöhe im Holz erstrecken.
- Höhe der Latte mindestens 40 mm!
- Höhe der Pfette mindestens 60 mm!



Abb. 10: Aufdachhalter verschraubt (Methode C)



Abb. 8: Lage der Stockschraube im Holz

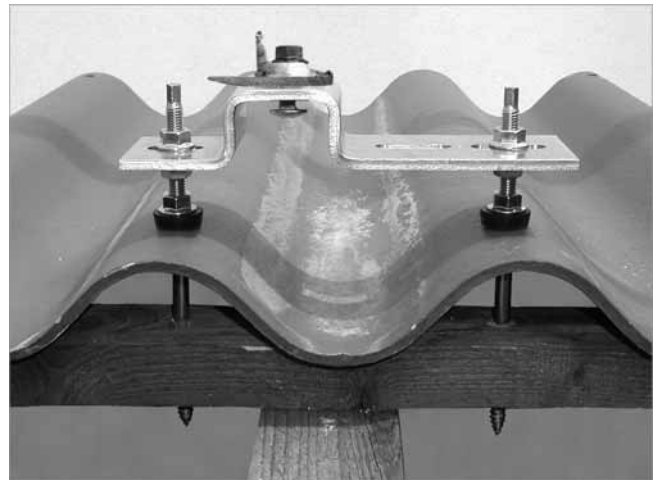

Weiter mit der Montage der Halteschienen, siehe → *Montageanleitung zum Kollektor.*

4. Aluprofil mit Haltewinkel montieren und in der Höhe ausrichten.

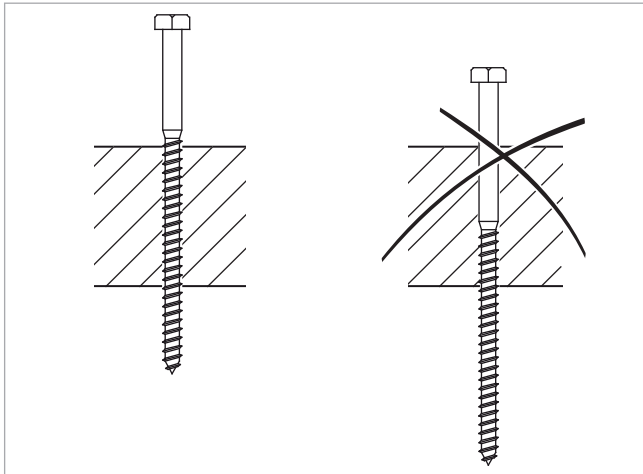
1 Installation of Roof-Mount Frame ADH-W

For corrugated roofs



Observe the safety notes

This is for your own safety.

- Make sure that you are familiar with the safety notes before beginning work.
- Observe and adhere to the relevant safety regulations and the valid accident prevention regulations.
- You should also follow the safety notes and any other notes from the available system documentation.



CAUTION

Observe instructions

Solvis is not liable for any damage resulting from non-observance of these instructions.

- Read the instructions carefully before operating or installing the system.
- Contact our Technical Sales department if you have any questions.



For additional information on statics, dimensions, etc., see the → *installation instructions for the collector.*



CAUTION

Be sure that all screw connections are tight

- Tighten all nuts after aligning the holding rails.

Scope of Delivery

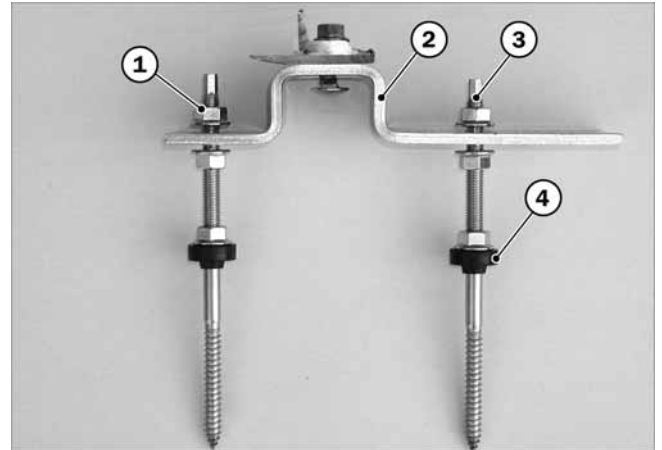

Fig. 11: Roof-mount frame ADH-W

- | | |
|---|----------------------|
| 1 Nuts, 6 pc. | 3 Hanger bolt, 2 pc. |
| 2 Aluminium profile with fixing bracket | 4 EPDM rubber gasket |

Roof Support Structure

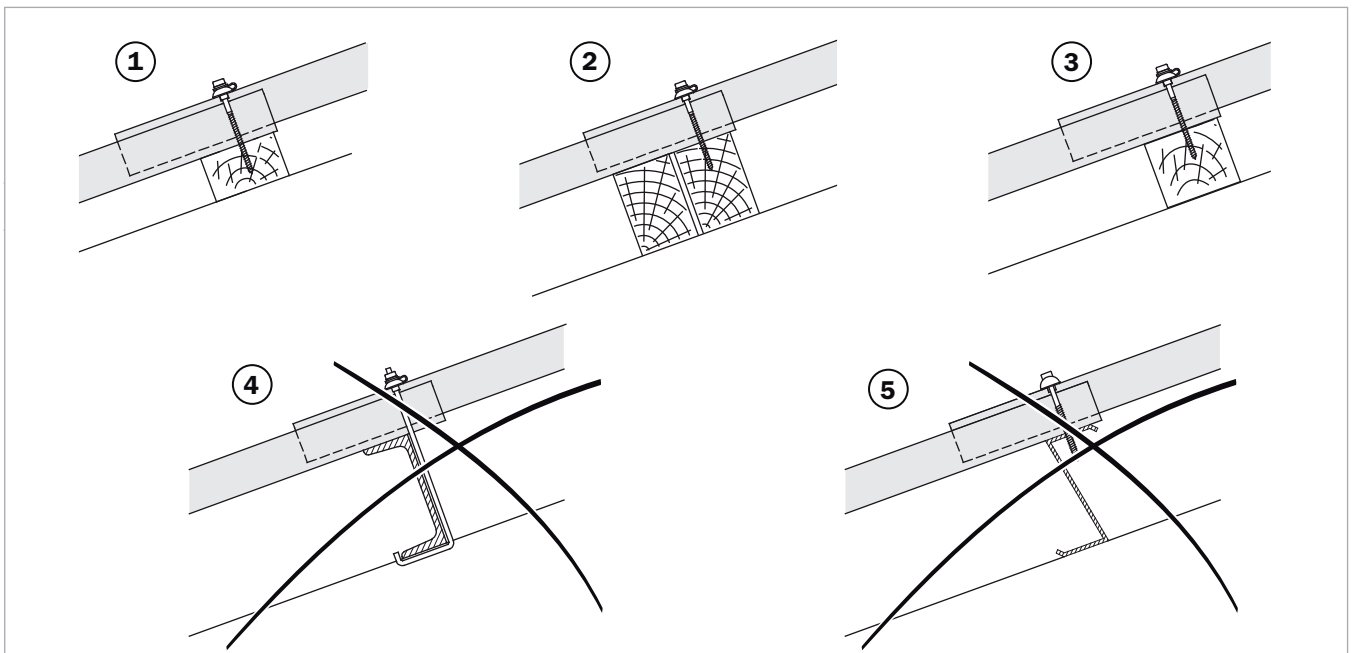



Fig. 12: Position of the hanger bolts

- | | |
|--------------------------------|------------------------------------|
| 1 Batten on rafter | 4 Steel girder (prohibited) |
| 2 Coupling batten on rafter | 5 Canted plate girder (prohibited) |
| 3 Purlin (at least 60 x 60 mm) | |

EN 1 Installation of Roof-Mount Frame ADH-W

Installation

 For the number of roof-mount frames and the distance between frames, see the → *Collector Installation Instructions*.



CAUTION

Always drill the wood beforehand.

Otherwise tears or cracks could result.

- In batten, purlin or rafters: 6 mm hole diameter
- In corrugated sheet, use a 13 mm masonry drill.

Three methods for positioning the roof-mount frame:

- Parallel to the rafter – both screws in the rafter
- Horizontal to the rafter – one screw in the rafter
- Horizontal to the rafter – rafter is between two screws

Installing the roof-mount frame parallel to the rafters

1. Method A: Place both hanger bolts in the rafters, tightening the EPDM gasket.

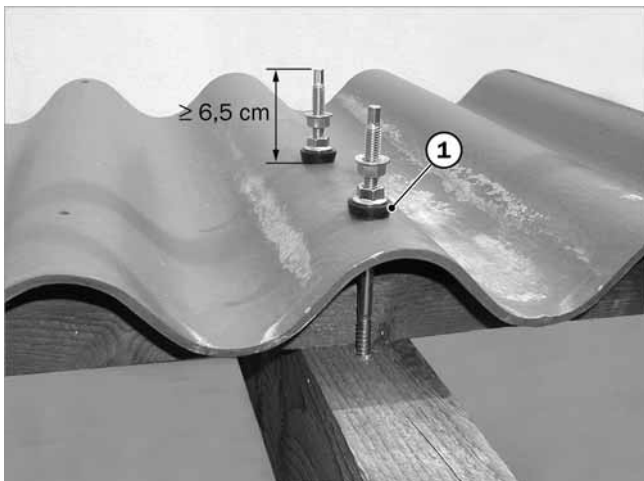

Fig. 13: Both hanger bolts in the rafter (Method A)

- 1 Screw in until tight
2. Attach the aluminium profile with the fixing bracket and adjust the height.

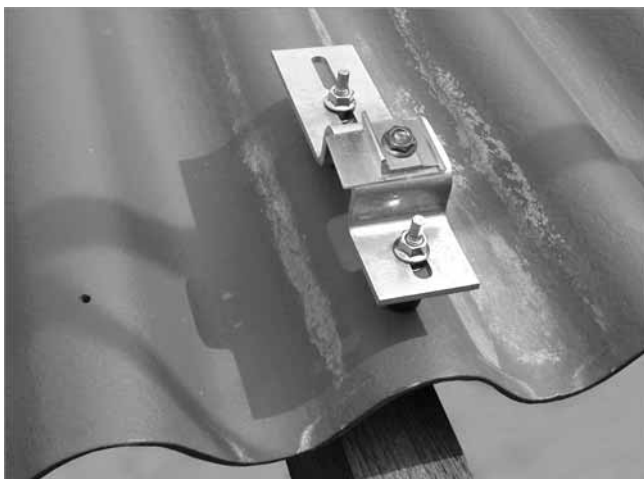

Fig. 14: Installed roof-mount frame (Method A)

Installing the roof-mount frame horizontal to the rafter

1. Position the hanger bolts, tightening the EPDM gasket. Method B: One screw in the rafter and one next to the rafter

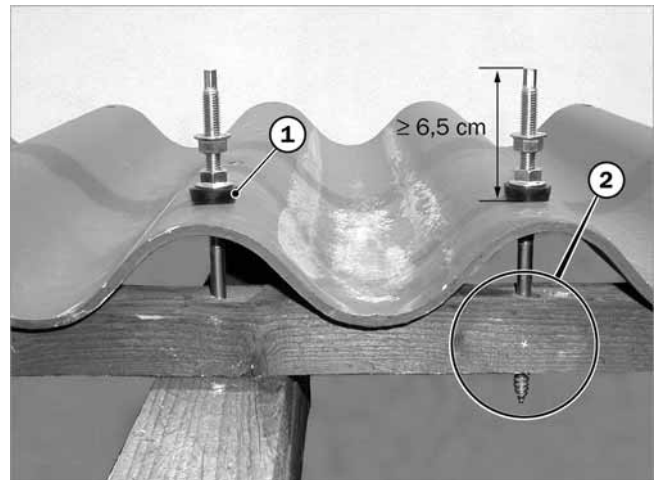

Fig. 15: 1 screw in the rafter, 1 screw in the batten (Method B)

- 1 Screw in until tight
- 2 Position of the screw → Fig. 18
2. Method C: Place both hanger bolts as close to the rafter as possible and tighten the gasket.

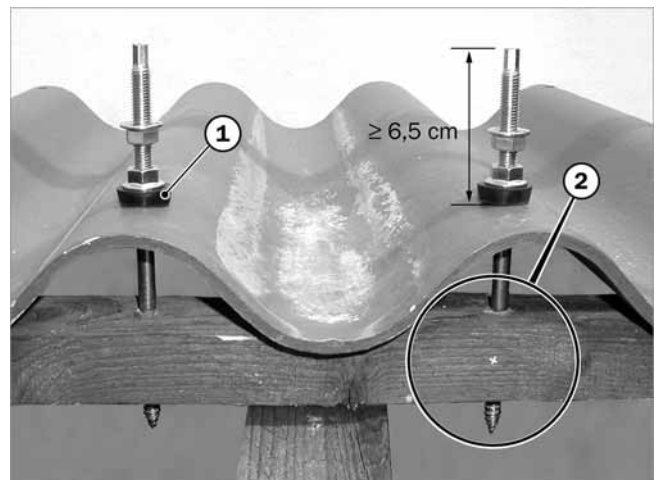

Fig. 16: 2 screws in the batten or purlin (Method C)

- 1 Screw in until tight
- 2 Position of the screw → Fig. 18
3. Never position the hanger bolts so that there is no rafter in between the bolts.

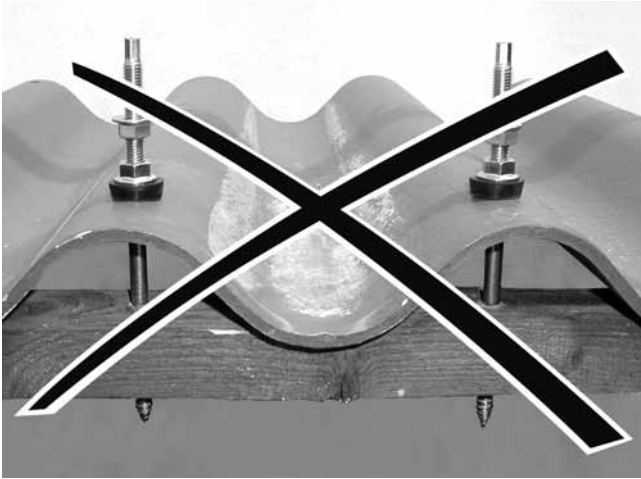

Fig. 17: **Prohibited.** Both hanger bolts positioned next to rafter



Fig. 19: Installed roof-mount frame (Method B)

CAUTION

Note the minimum height
 Otherwise sufficient load bearing capacity cannot be ensured.

- The screw thread must extend into the wood past the overall minimum height.
- Minimum height of the batten: 40 mm
- Minimum height of the purlin: 60 mm

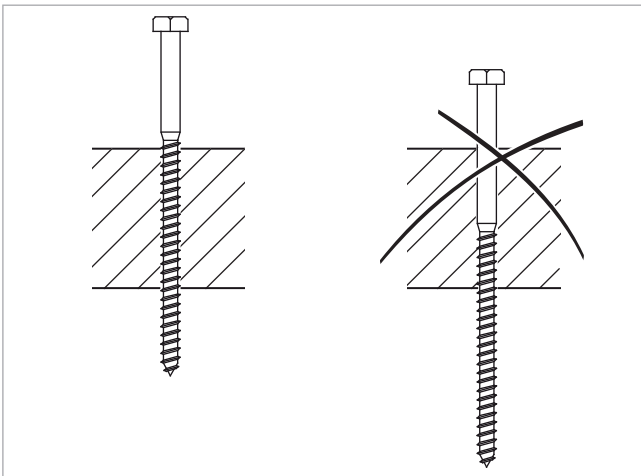

Fig. 18: Position of the hanger bolt in the wood

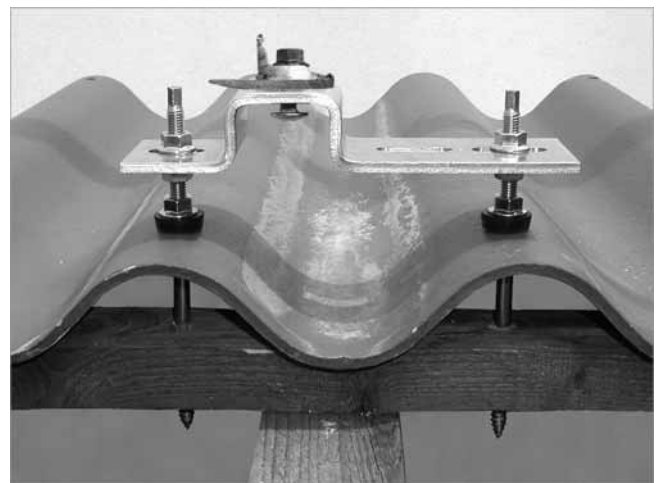



Fig. 20: Installed roof-mount frame (Method C)

 Continue with the installation of the holding rails: see the → *installation instructions for the collector.*

4. Attach the aluminium profile with the fixing bracket and adjust the height.

1 Montaggio del supporto per fissaggio sul tetto ADH-W

Per il tetto ondulato



Osservare le Indicazioni per la sicurezza

Questo serve soprattutto per proteggere la propria persona.

- Prima dell'inizio dei lavori è necessario prendere conoscenza delle indicazioni per la sicurezza.
- Osservare e attenersi alle relative prescrizioni per la sicurezza e alle norme antinfortunistiche in vigore.
- Sono inoltre valide le indicazioni per la sicurezza e le altre indicazioni contenute nella presente documentazione dell'impianto.



ATTENZIONE

Osservare le Istruzioni

Solvis declina ogni responsabilità per danni derivanti dall'inosservanza di queste Istruzioni.

- Prima dell'impiego o dell'installazione, leggere attentamente le Istruzioni.
- Per eventuali domande è disponibile il Servizio per la Distribuzione tecnica della Solvis.



I dati supplementari relativi alla statica, le dimensioni e altro, vedere → *Istruzioni per il montaggio dei collettori.*



ATTENZIONE

Osservare la salda sede dei collegamenti a vite

- Dopo l'allineamento, stringere saldamente tutti i dadi della traversa!

Volume di fornitura

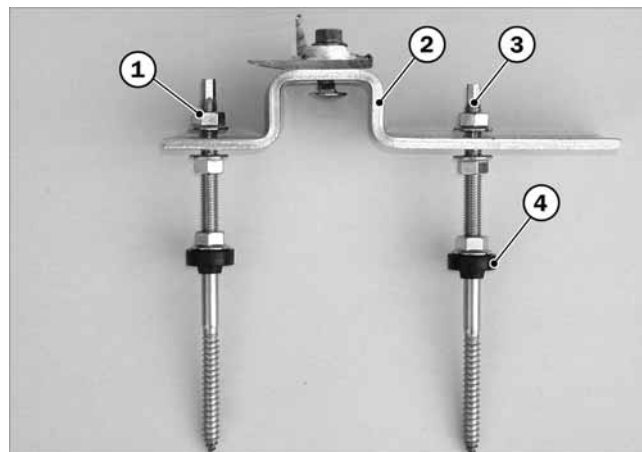

Fig. 21: Supporto per fissaggio sul tetto ADH-W

- | | |
|---|-----------------------------|
| 1 Dadi, 6 pezzi | 3 Viti prigioniere, 2 pezzi |
| 2 Profilo in alluminio con angolare di supporto | 4 Guarnizione in gomma EPDM |

Sottostruttura del tetto

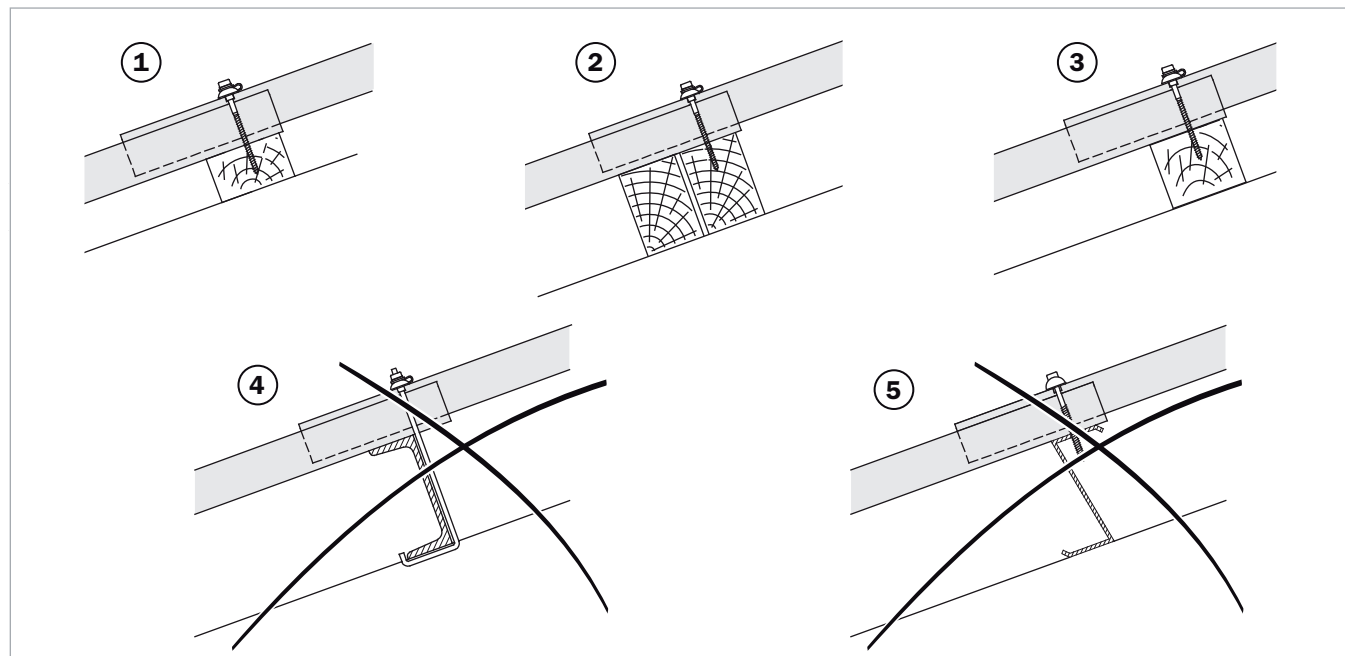

Fig. 22: posizione delle viti prigioniere

- | | |
|--|--|
| 1 Listello su falso puntone | 4 Supporto in acciaio (non permesso) |
| 2 Listello di accoppiamento su falso puntone | 5 Supporto in lamiera piegata (non permesso) |
| 3 Arcareccio (min. 60 x 60 mm) | |

Montaggio

Per il numero e le distanze dei supporti per fissaggio sul tetto, vedi → *Istruzioni di montaggio del collettore.*

**ATTENZIONE**

Effettuare sempre la foratura di sgrosso per evitare che si formino crepe o fessure nel legno.

- Nell'arcareccio, nel listello o nel falso puntone: diametro foro 6 mm
- Nella piastra ondulata utilizzare una punta da roccia da 13 mm.

Tre metodi per disporre il supporto per fissaggio sul tetto:

- parallelo al falso puntone, entrambe le viti nel falso puntone
- trasversale al falso puntone, una vite nel falso puntone
- trasversale al falso puntone, il falso puntone tra due viti.

Montaggio del supporto per fissaggio sul tetto parallelo al falso puntone

1. Metodo A: inserire entrambe le viti prigioniere nel falso puntone e serrare la guarnizione in EPDM.

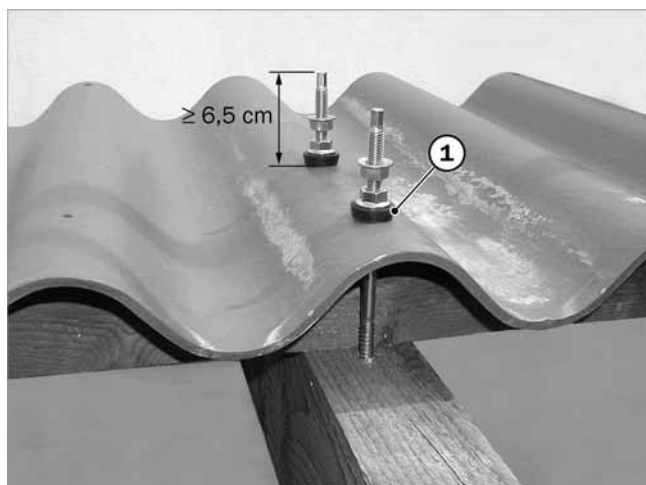

Fig. 23: entrambe le viti prigioniere nel falso puntone (metodo A)

- 1 Serrare a tenuta

2. Montare il profilo in alluminio con l'angolare di supporto e regolare in altezza.

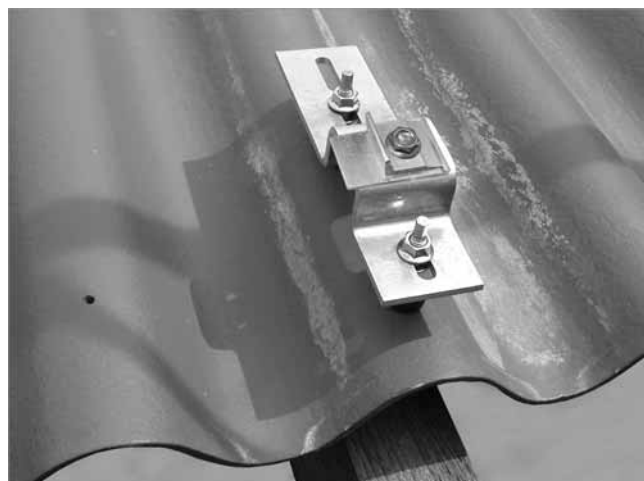

Fig. 24: supporto per fissaggio sul tetto avvitato (metodo A)

Supporto per fissaggio sul tetto trasversale al falso puntone

1. Inserire le viti prigioniere e serrare la guarnizione in EPDM. Metodo B: una vite nel falso puntone e una a fianco.

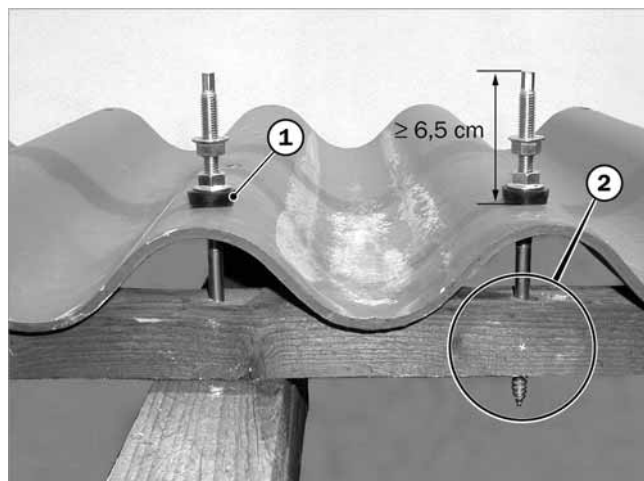

Fig. 25: 1 vite nel falso puntone, 1 vite nell'arcareccio (metodo B)

- 1 Serrare a tenuta
- 2 Posizione della vite → Fig. 28

2. Metodo C: serrare il più possibile entrambe le viti prigioniere accanto al falso puntone e serrare la guarnizione.

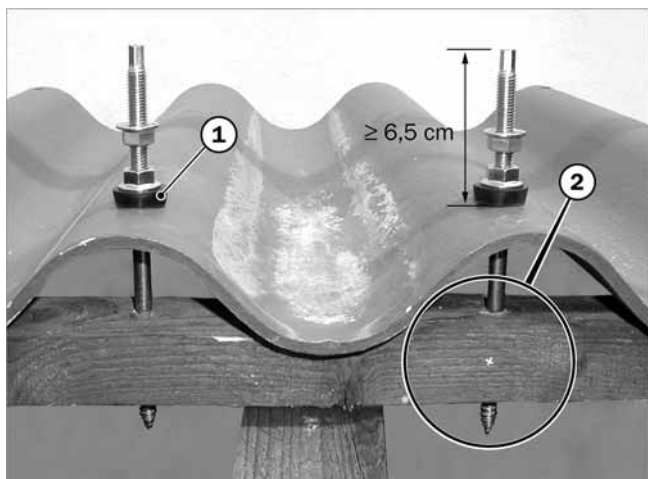

Fig. 26: 2 viti nell'arcareccio o nel listello (metodo C)

- 1 Serrare a tenuta
- 2 Posizione della vite → Fig. 28
3. Non avvitare mai le due viti prigioniera senza falso puntone in mezzo.

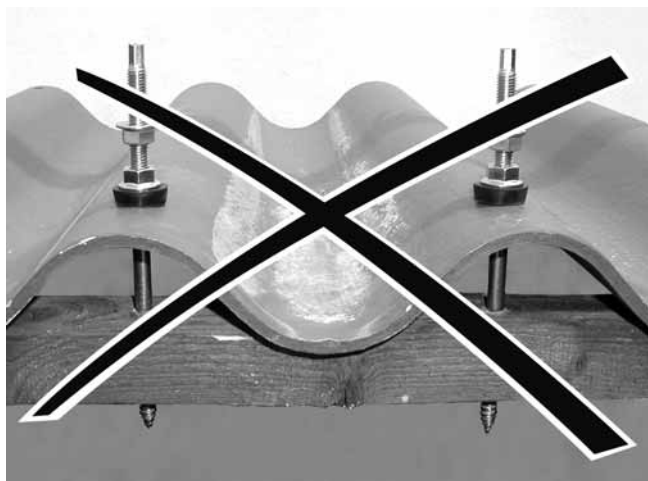

Fig. 27: **Vietato:** viti prigioniera accanto al falso puntone



ATTENZIONE

Osservare l'altezza minima

In caso contrario non è garantita una portata sufficiente.

- La filettatura della vite deve estendersi nel legno per l'altezza minima complessiva.
- Altezza minima dell'arcareccio 40 mm!
- Altezza minima del listello 60 mm!

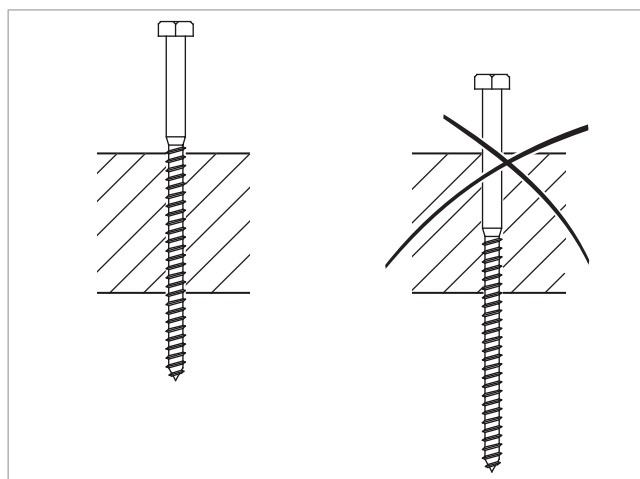

Fig. 28: posizione della vite prigioniera nel legno

4. Montare il profilo in alluminio con l'angolare di supporto e regolare in altezza.



Fig. 29: supporto per fissaggio sul tetto avvitato (metodo B)

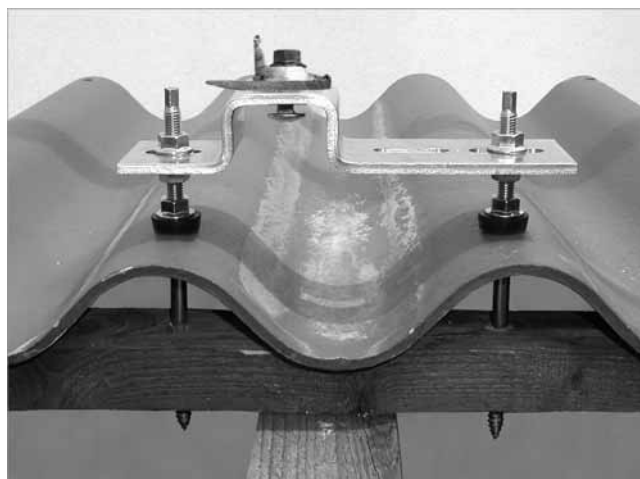

Fig. 30: supporto per fissaggio sul tetto avvitato (metodo C)



Proseguire con il montaggio delle traverse, vedere → Istruzioni per il montaggio del collettore.

1 Montaje de soporte para tejado ADH-W

Para tejado ondulado



Observe las instrucciones de seguridad

Están pensadas principalmente para su propia seguridad.

- Antes de empezar con los trabajos, familiarícese con las instrucciones de seguridad.
- Observe y cumpla las disposiciones legales en materia de seguridad y las prescripciones vigentes para la prevención de accidentes.
- Tienen también validez las instrucciones de seguridad y las demás indicaciones de la presente documentación de la instalación.



ATENCIÓN

Observar las instrucciones

Solvis no se responsabilizará por los daños que surjan de la no observación de estas instrucciones.

- Antes de empezar el manejo o la instalación, lea atentamente las instrucciones.
- El Servicio técnico de Solvis está a su disposición para cualquier consulta.



Se indican datos complementarios sobre estática, dimensiones, etc., véase → *Instrucciones de montaje del colector.*



ATENCIÓN

Asegurarse de que las uniones roscadas están fijadas

- Después de nivelar los rieles de sujeción, apriete todas las tuercas.

Volumen de suministro

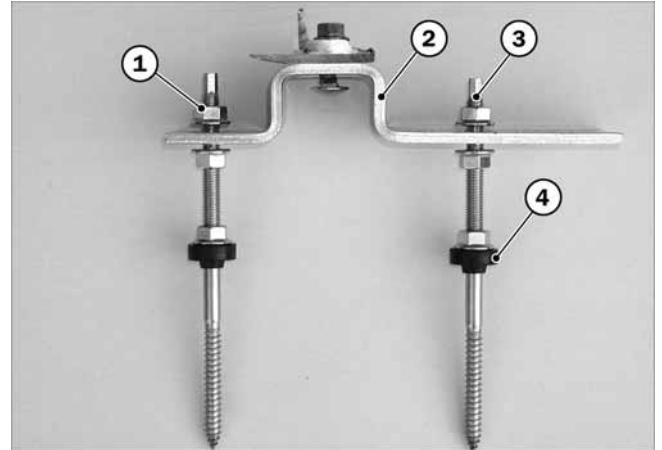

Fig. 31: Soporte sobre tejado ADH-W

- | | |
|---|--------------------------|
| 1 Tuerca, 6 unidades | 3 Tirafondos, 2 unidades |
| 2 Perfil de aluminio con ángulo de sujeción | 4 Junta de caucho EPDM |

Subestructura del tejado

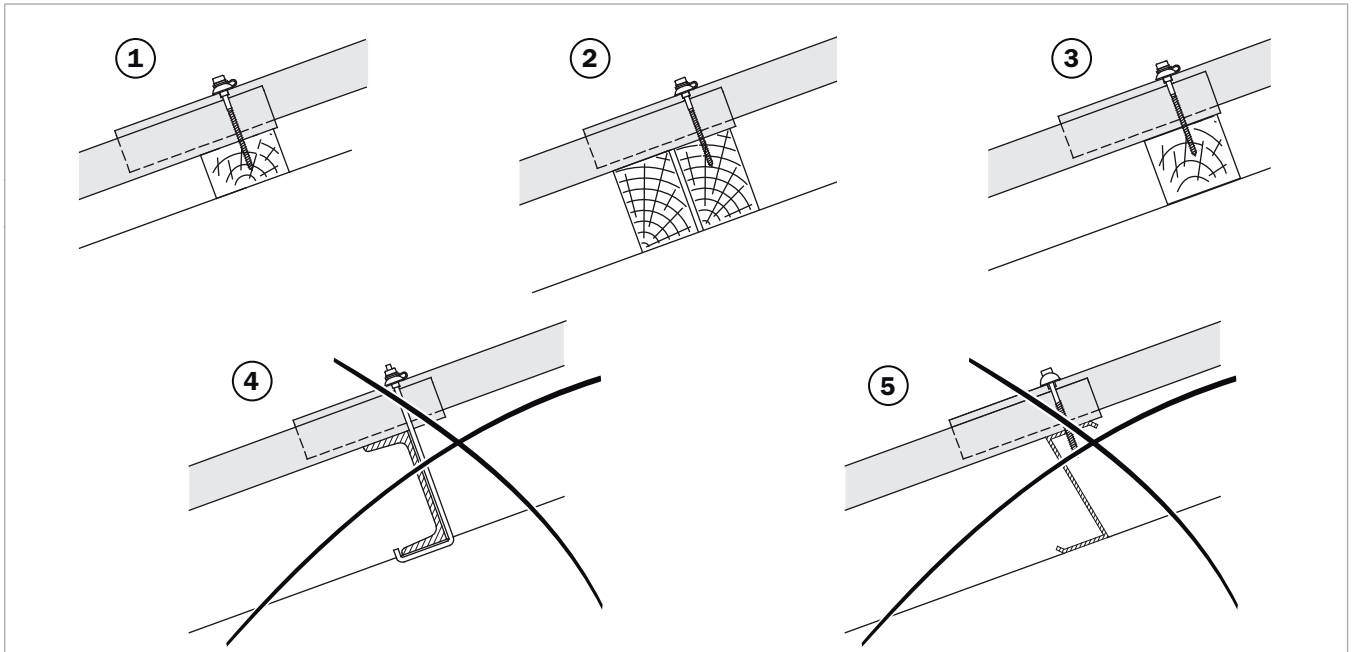



Fig. 32: Ubicación de los tirafondos

- | | |
|-------------------------------------|---|
| 1 Ripia sobre cabio | 4 Viga de acero (no permitida) |
| 2 Ripia de acoplamiento sobre cabio | 5 Viga de chapa canteada (no permitida) |
| 3 Correa (mín. 60 x 60 mm) | |

Montaje

 Para el número y las distancias de los soportes sobre tejado, véanse → *instrucciones de montaje para el colector.*



ATENCIÓN

Siempre pretaladrar la madera

En caso contrario, es posible formación de grietas o hendidura.

- En ripia, correa o cable: 6 mm de diámetro de agujero
- En plancha ondulada utilizar broca para piedra de 13 mm.

Tres métodos para posicionar el soporte sobre tejado:

- en paralelo al cable, ambos tornillos en el cable
- transversalmente al cable, un tornillo en el cable
- transversalmente al cable, cable entre 2 tornillos.

Montar el soporte sobre tejado en paralelo al cable

1. Método A: Colocar ambos tirafondos en el cable, apretando la junta de EPDM.

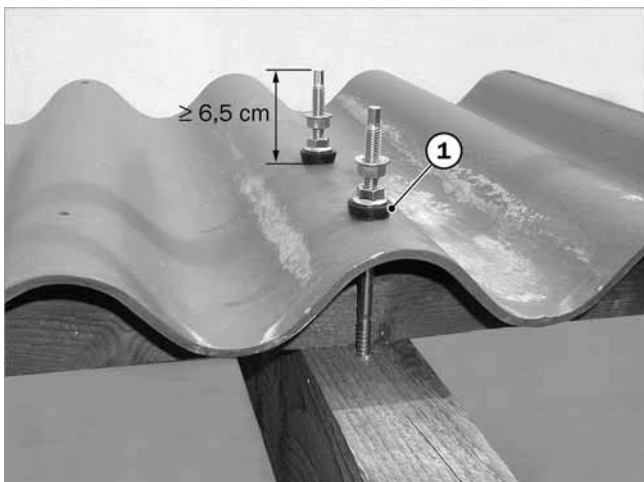

Fig. 33: Ambos tirafondos en el cable (método A)

- 1 Apretar para hermetizar
- 2 Montar perfil de aluminio con ángulo de sujeción y alinearlos en la altura.

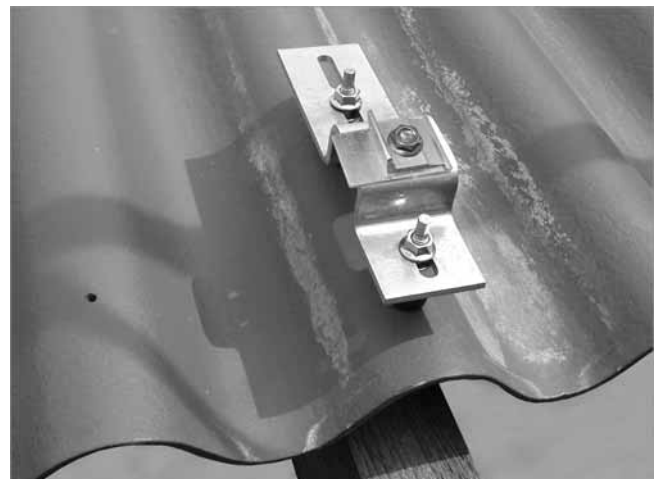

Fig. 34: Soporte sobre tejado atornillado (método A)

Montar el soporte sobre tejado transversalmente al cable

1. Colocar tirafondos, apretando junta de EPDM. Método B: un tornillo en el cable y otro al lado.

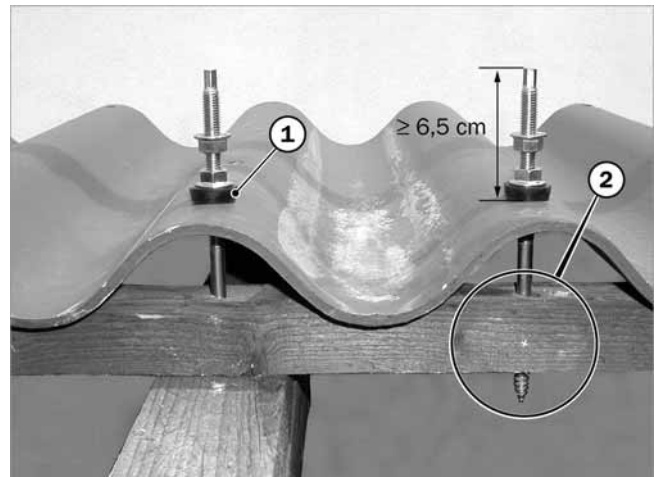

Fig. 35: Tornillo 1 x en cable, 1 x en ripia (método B)

- 1 Apretar para hermetizar
- 2 Posición del tornillo → Fig. 38
2. Método C: Colocar ambos tirafondos lo más cerca posible al lado del cable y apretar la junta.

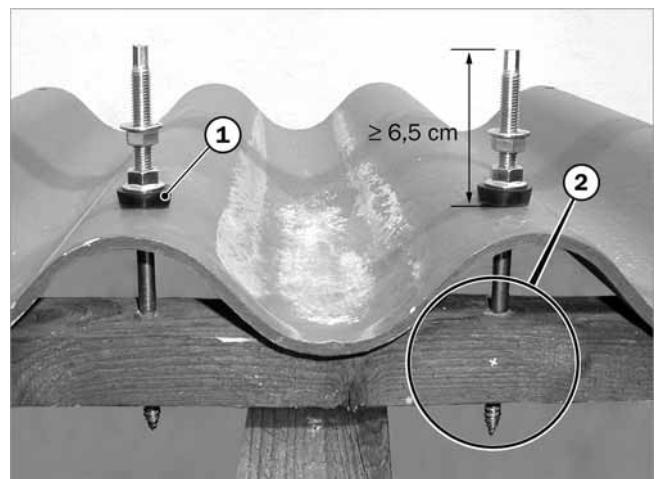

Fig. 36: Tornillo 2 x en ripia o correa (método C)

- 1 Apretar para hermetizar
- 2 Posición del tornillo → Fig. 38
3. En ningún caso colocar ambos tirafondos de manera que no haya ningún cabio entre ellos.

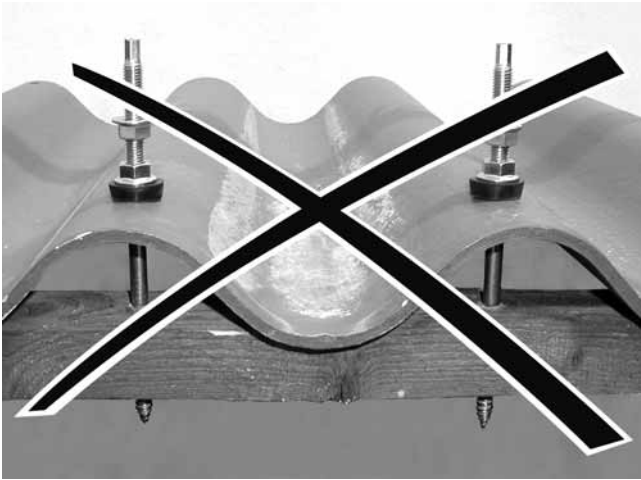

Fig. 37: **Prohibido.** Tirafondos colocados al lado del cabio



ATENCIÓN

Observar altura mínima

En caso contrario, no está garantizada capacidad de carga suficiente.

- La rosca del tornillo debe extenderse en la madera a lo largo de toda la altura mínima.
- Altura de la ripia al menos 40 mm.
- Altura de la correa al menos 60 mm.

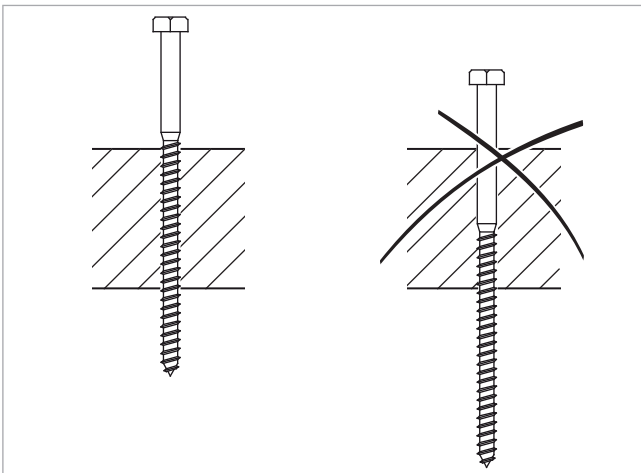

Fig. 38: Posición del tirafondos en la madera

4. Montar perfil de aluminio con ángulo de sujeción y alinearlo en la altura.



Fig. 39: Soporte sobre tejado atornillado (método B)

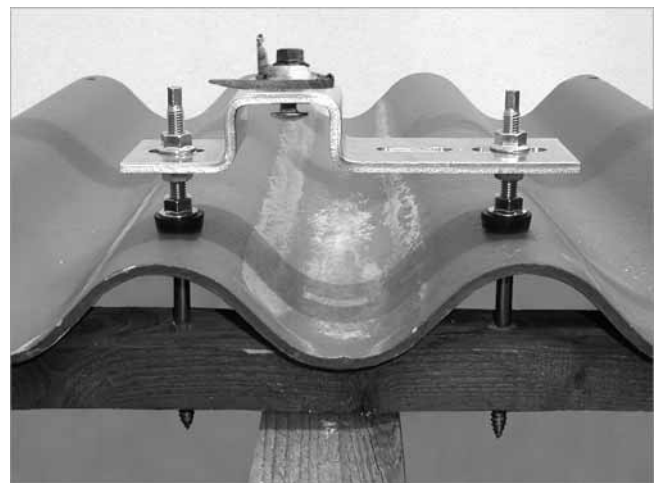

Fig. 40: Soporte sobre tejado atornillado (método C)



Continúe con el montaje de los rieles de soporte, véase → *Instrucciones de montaje del colector.*

1 Montagem de suporte de telhado ADH-W

Para telhado ondulado



Observar as instruções de segurança

Estas informações ajudarão a evitar situações que possam por em risco a sua própria segurança.

- Antes de iniciar os trabalhos, familiarize-se com as instruções de segurança.
- Observar e respeitar os regulamentos de segurança e de prevenção de acidentes válidos.
- Além destes regulamentos, aplicam-se também as instruções de segurança e as restantes notas da documentação da do sistema.



ATENÇÃO

Observar as instruções

A Solvis não se responsabiliza por danos causados em consequência da não observação das informações apresentadas nestas instruções.

- Leia o manual de instruções antes da instalação e utilização do aparelho.
- Em caso de dúvidas ou problemas, contacte o departamento técnico de vendas da Solvis.



Para as informações complementares sobre estática, dimensões, etc., ver → *instruções de montagem do colector*



ATENÇÃO

Garantir que os parafusos estão bem apertados

- Após o ajuste, apertar bem todas as porcas dos carris de suporte!

Fornecimento

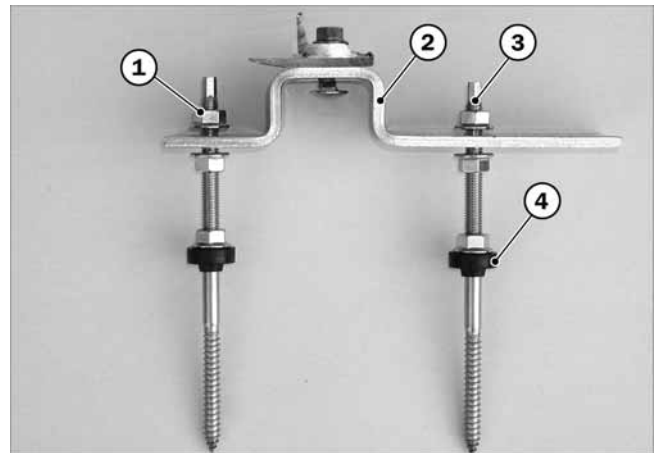

Fig. 41: Suporte para telhados ADH-W

- | | |
|--|------------------------------------|
| 1 Porca, 6 unid. | 3 Parafuso de rosca dupla, 2 unid. |
| 2 Perfil de alumínio com ângulo de fixação | 4 Vedante de borracha EPDM |

Estrutura de suporte do telhado

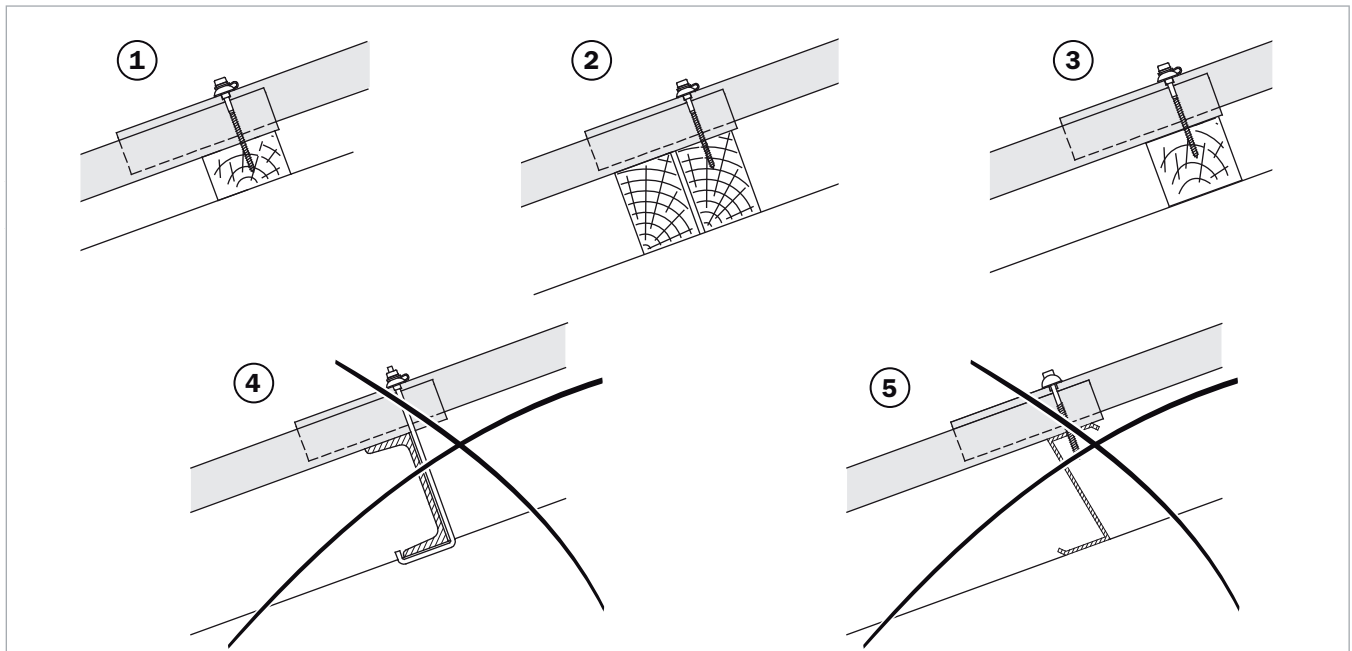



Fig. 42: Posição dos parafusos de rosca dupla

- | | |
|--------------------------------|---|
| 1 Ripras sobre vigas | 4 Suporte de aço (não permitido) |
| 2 Ripras acopladas sobre vigas | 5 Suporte de chapa facetado (não permitido) |
| 3 Travessa (mín. 60 x 60 mm) | |

Montagem

 No que diz respeito ao afastamento dos suportes para telhados, consulte → *Instruções de montagem do coletor.*



ATENÇÃO

Pré-perfurar sempre a madeira

Caso contrário, podem formar-se fissuras ou fendas.

- Nas ripas, travessas ou vigas: diâmetro do furo 6 mm
- Na placa ondulada, utilizar uma broca para pedra de 13 mm.

Existem três métodos de posicionar o suporte para telhados:

- paralelamente à viga, ambos os parafusos na viga
- transversalmente à viga, um parafuso na viga
- transversalmente à viga, viga entre 2 parafusos.

Montar o suporte para telhados paralelamente à viga

1. Método A: Colocar ambos os parafusos de rosca dupla na viga, apertando a vedação EPDM.

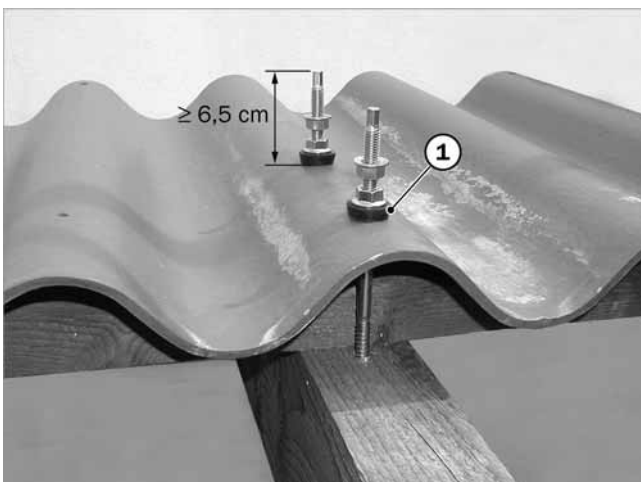

Fig. 43: Ambos os parafusos de rosca dupla nas vigas (método A)

- 1 Apertar firmemente até vedar
2. Montar o perfil de alumínio com o ângulo de fixação e alinhar em altura.

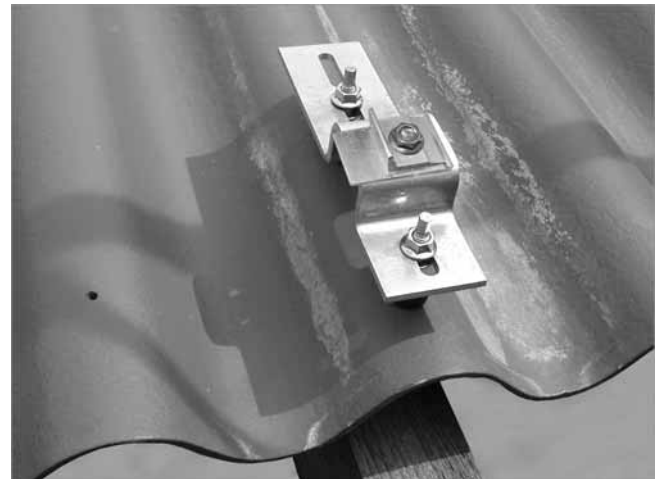

Fig. 44: Suporte para telhados aparafusado (método A)

Montar o suporte para telhados transversalmente à viga

1. Colocar os parafusos com rosca dupla, apertando firmemente a vedação EPDM. Método B: um parafuso no viga e outro ao lado.

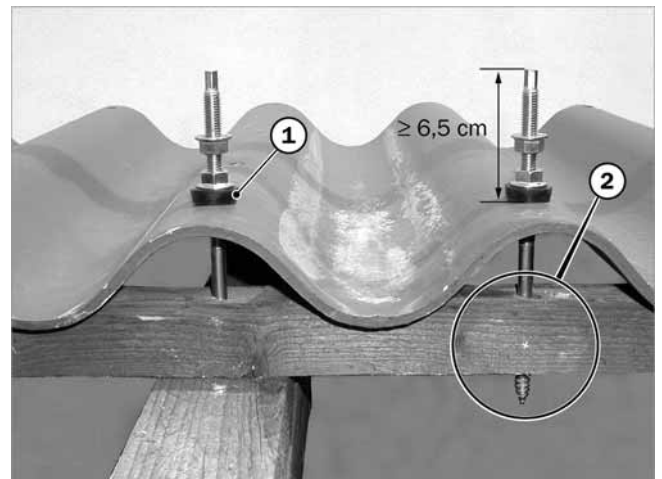

Fig. 45: 1 parafuso na viga, 1 parafuso na ripa (método B)

- 1 Apertar firmemente até vedar
- 2 Posição do parafuso → Fig. 48
2. Método C: posicionar os dois parafusos de rosca dupla o mais próximo possível da viga e apertar até vedar.

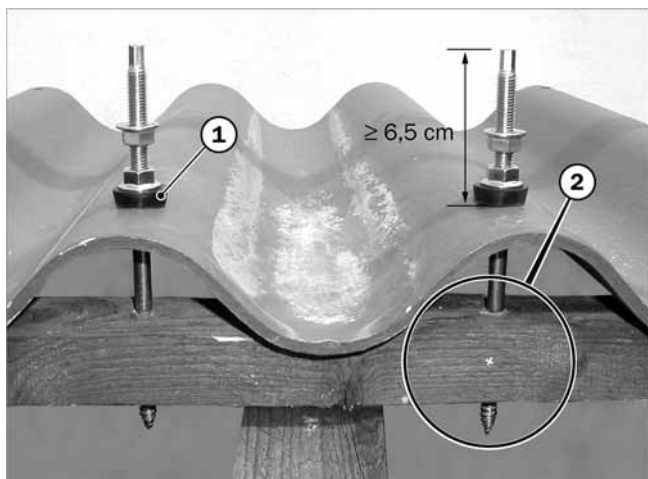

Fig. 46: 2 parafusos na ripa ou na travessa (método C)

- 1 Apertar firmemente até vedar
- 2 Posição do parafuso → Fig. 48
3. Nunca posicionar ambos os parafusos de rosca dupla sem que exista uma viga no meio.

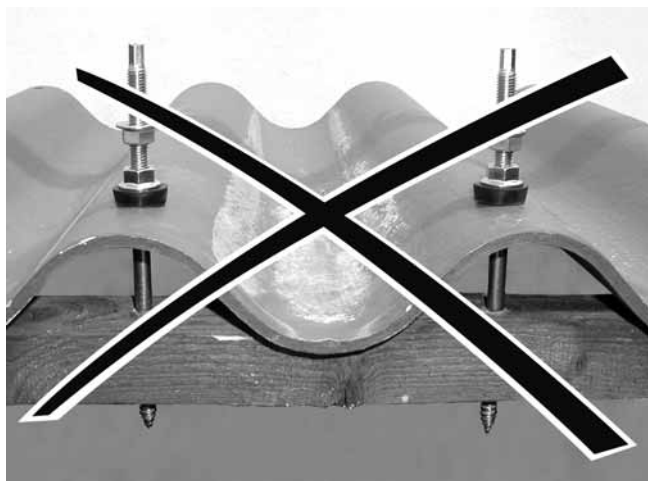

Fig. 47: **Proibido:** parafusos de rosca dupla posicionados ao lado da viga



ATENÇÃO

Prestar atenção à altura mínima

Caso contrário, não é assegurada uma capacidade de carga suficiente.

- A rosca dos parafusos deve penetrar na madeira para além da altura mínima total.
- Altura mínima da ripa: 40 mm!
- Altura mínima da travessa: 60 mm!

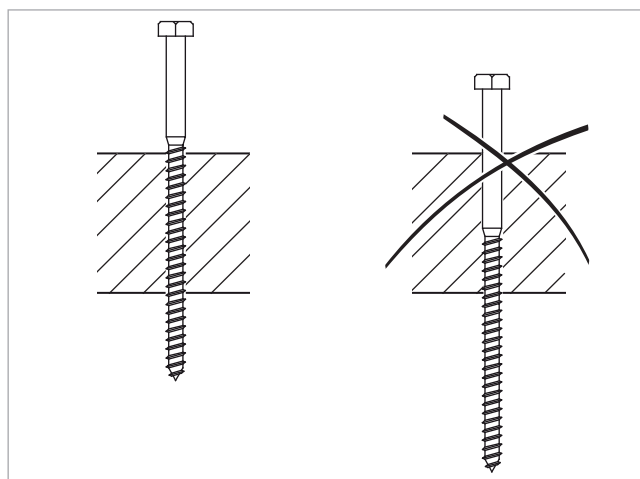

Fig. 48: Posição do parafuso de rosca dupla na madeira

4. Montar o perfil de alumínio com o ângulo de fixação e alinhar em altura.



Fig. 49: Suporte para telhados aparafusado (método B)

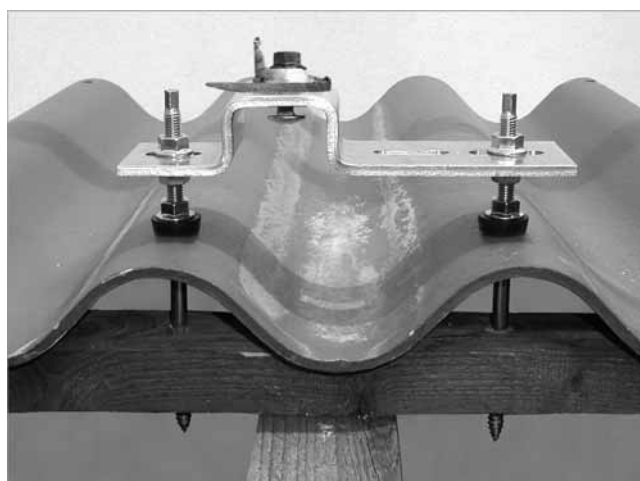

Fig. 50: Suporte para telhados aparafusado (método C)



Para a montagem dos carris de suporte, ver → instruções de montagem do colectora.

1 Montage de la Fixation sur toiture ADH-W

Pour toiture ondulée



Respectez les consignes de sécurité

Il en va de votre propre sécurité.

- Avant de débiter les travaux, familiarisez-vous avec les consignes de sécurité.
- Respectez les consignes de sécurité ainsi que les prescriptions de prévention des accidents en vigueur.
- Veuillez également respecter les consignes de sécurité ainsi que les remarques de la documentation de l'installation déjà en votre possession.



ATTENTION

Respecter les instructions

Solvis décline toute responsabilité pour les dommages occasionnés par le non-respect de ces instructions.

- Avant toute utilisation ou installation, lire attentivement les instructions.
- En cas de questions, le service technique de Solvis est à votre disposition.



Vous obtiendrez des informations complémentaires concernant la statique, les dimensions, etc. dans les → *instructions de montage du capteur.*



ATTENTION

Contrôlez le bon serrage des raccords vissés

- Après l'ajustage des rails de support, serrez tous les écrous.

Volume de livraison

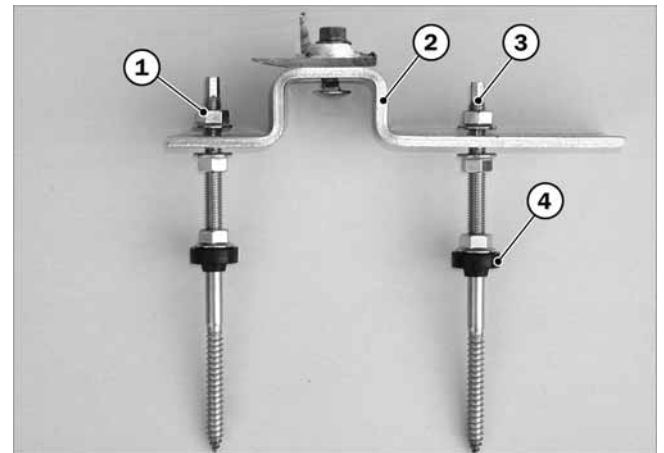

Fig. 51 : fixation sur toiture ADH-W

- | | |
|--|-----------------------------------|
| 1 Écrou, 6 unités | 3 Vis à double filetage, 2 unités |
| 2 Profil aluminium avec équerre de support | 4 Garniture EPDM |

Socle du toit

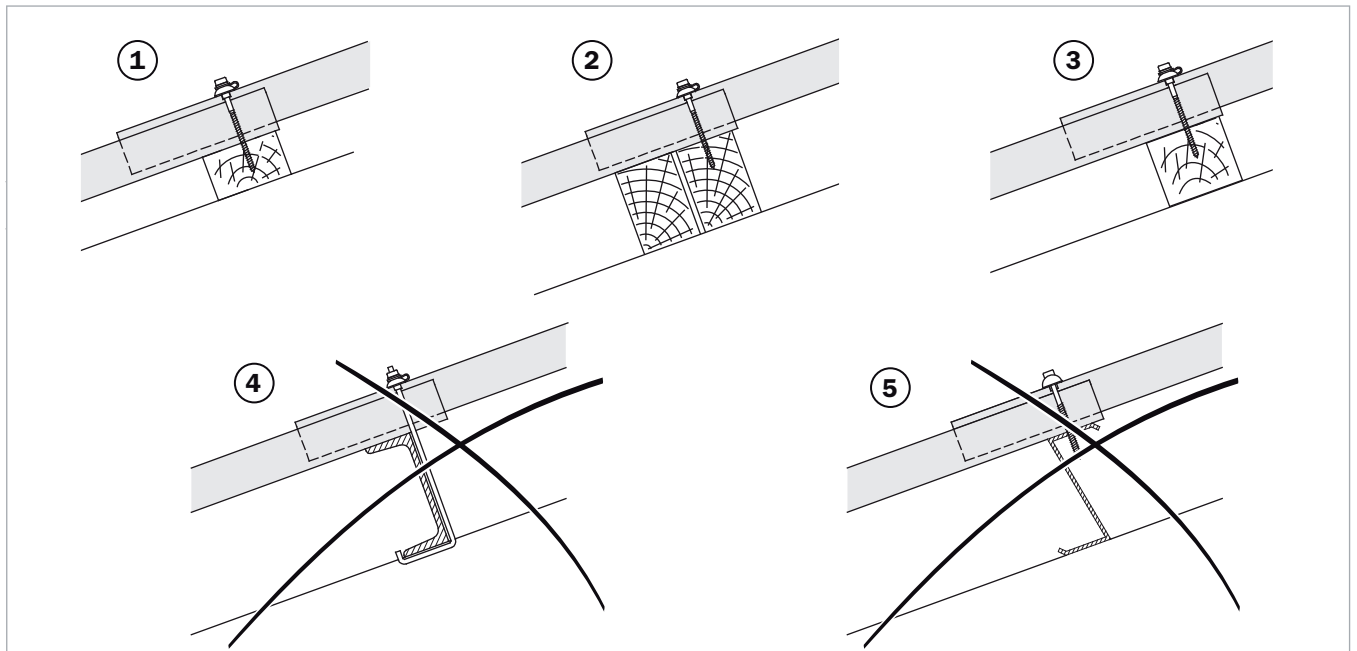



Fig. 52 : emplacement des vis à double filetage

- | | |
|------------------------------------|--|
| 1 Linteau sur chevron | 4 Poutre d'acier (non autorisé) |
| 2 Latte d'accouplement sur chevron | 5 Support en tôle formé (non autorisé) |
| 3 panne (60 x 60 mm minimum) | |

Montage

 Veuillez consulter les → *Instructions de montage du capteur* pour toute indication concernant le nombre de fixations sur toiture et les distances entre les fixations.

! ATTENTION
Pré-percez impérativement le bois
 Risque de formation de fentes ou de rupture du bois dans le cas contraire.

- Dans le liteau, la panne ou le chevron : trou d'un diamètre de 6 mm
- Dans une plaque ondulée, utilisez un foret à béton de 13 mm.

Trois méthodes pour placer la fixation sur toiture :

- parallèlement au chevron, les deux vis dans le chevron
- perpendiculairement au chevron, une vis dans le chevron
- perpendiculairement au chevron, le chevron entre 2 vis.

Montage de la fixation sur toiture parallèlement au chevron

1. Méthode A : placez les deux vis à double filetage dans le chevron tout en serrant la garniture EPDM.

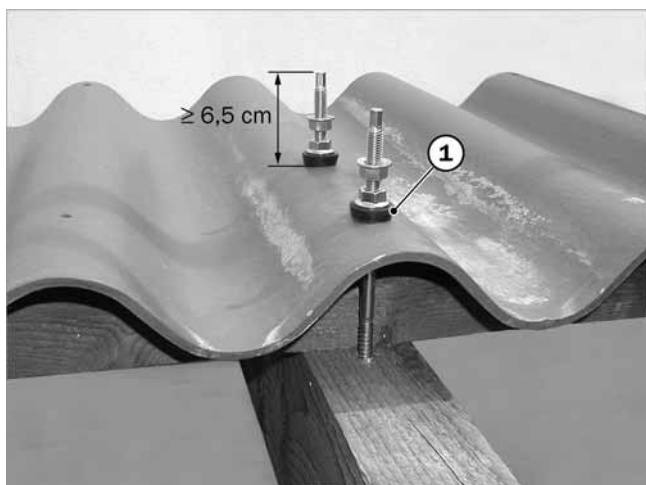

Fig. 53 : les deux vis à double filetage dans le chevron (méthode A)

- 1 Serrage de la garniture
2. Installez le profil en aluminium avec l'équerre de support, puis ajustez la hauteur.

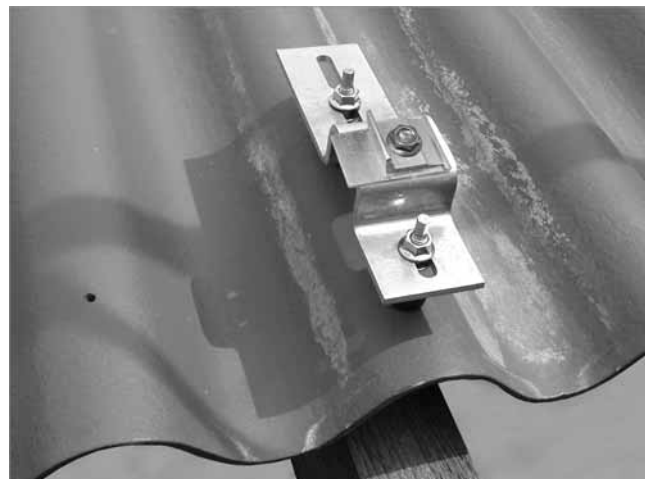

Fig. 54 : fixation sur toiture vissée (méthode A)

Montage de la fixation sur toiture parallèlement au chevron

1. Placez les vis à double filetage tout en serrant la garniture EPDM. Méthode B : une vis dans le chevron et une vis à côté.

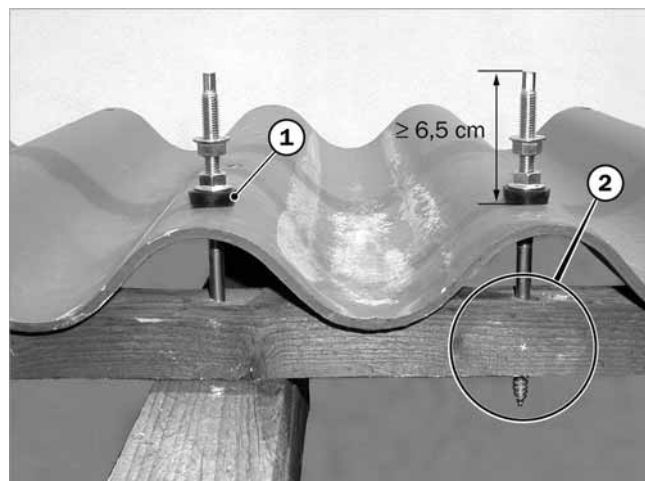

Fig. 55 : 1 vis dans le chevron, 1 vis dans le liteau (méthode B)

- 1 Serrage de la garniture
 2 Position de la vis → fig. 58
2. Méthode C : placez les deux vis à double filetage aussi près que possible du chevron, puis serrez la garniture.

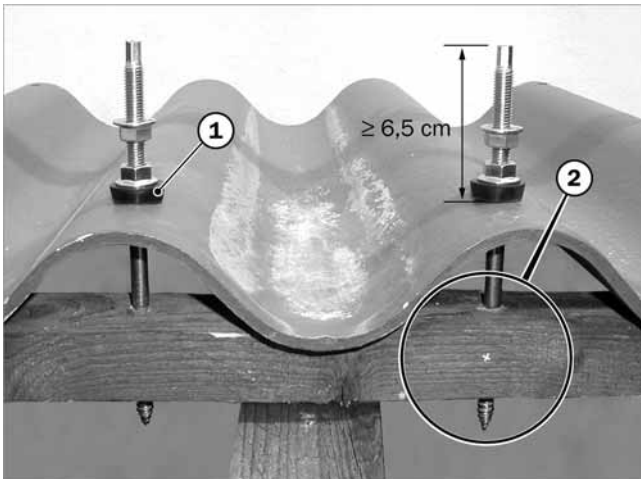

Fig. 56 : 2 vis dans le linteau ou dans la panne (méthode C)

- 1 Serrage de la garniture
- 2 Position de la vis → fig. 58

3. Ne placez en aucun cas les deux vis à double filetage de sorte qu'aucun chevron n'apparaisse entre les vis.

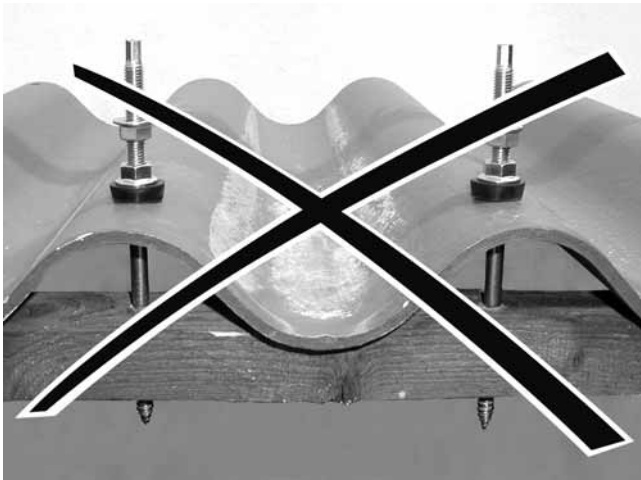

Fig. 57 : **Interdit**: Vis à double filetage placées à côté du chevron



ATTENTION

Respectez la hauteur minimale

Sinon, la portance suffisante ne serait pas garantie.

- Le filetage de la vis doit pénétrer le bois dans toute la hauteur minimale.
- Hauteur minimale du linteau : 40 mm.
- Hauteur minimale de la panne : 60 mm.

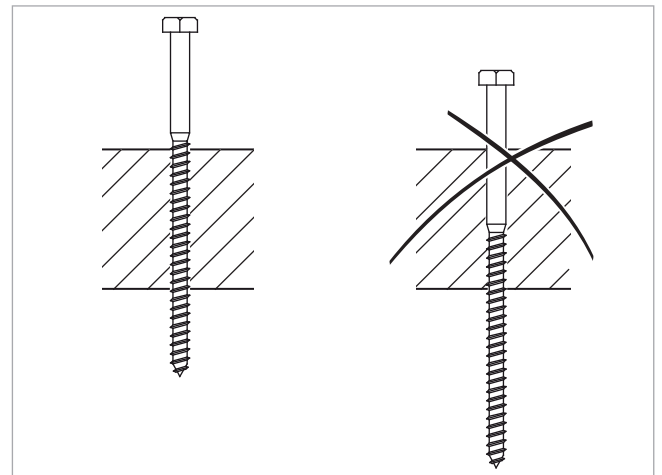

Fig. 58 : position de la vis à double filetage dans le bois

4. Installez le profil en aluminium avec l'équerre de support, puis ajustez la hauteur.



Fig. 59 : fixation sur toiture vissée (méthode B)

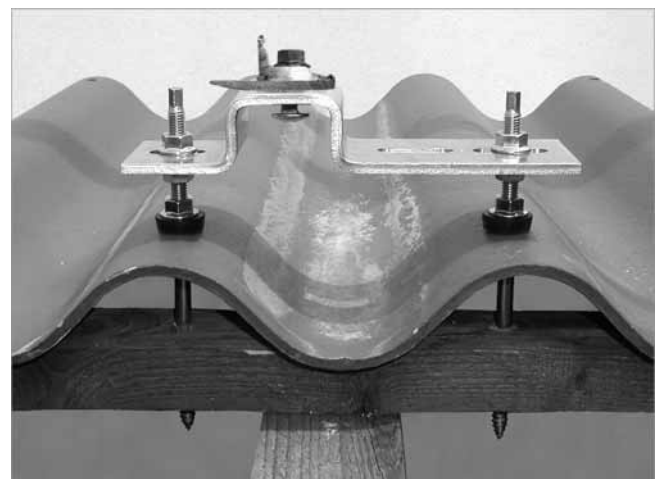

Fig. 60 : fixation sur toiture vissée (méthode C)



Suite du montage des rails de support dans les → instructions de montage du capteur.

1 Montage van Opbouw-dakbeugel ADH-W

Voor het golfplaten dak



Veiligheidsinstructies in acht nemen

Dit is van groot belang voor uw eigen veiligheid.

- Vóór het begin van de werkzaamheden met de veiligheidsinstructies vertrouwd raken.
- De desbetreffende veiligheidsbepalingen en geldende voorschriften ter voorkoming van arbeidsongevallen in acht nemen en naleven.
- Tevens gelden de aanwijzingen en veiligheidsinstructies zoals beschreven in de reeds beschikbare documentatie van de installatie.



ATTENTIE

Montage-instructies in acht nemen

Solvis kan niet aansprakelijk worden gesteld voor schade of gevolgschade die door het niet in acht nemen van deze handleiding ontstaat.

- Vóór bediening of installatie de montage-instructies zorgvuldig doorlezen.
- In geval van vragen staat de technische verkoop van Solvis graag met raad en daad ter beschikking.



Aanvullende informatie aangaande de statica, afmetingen e.d., zie → *montagehandleiding van de collector.*



ATTENTIE

Let op dat de boutverbindingen stevig vastgedraaid zijn

- Na het richten van de klemrails alle moeren vastdraaien!

Omvang van de levering

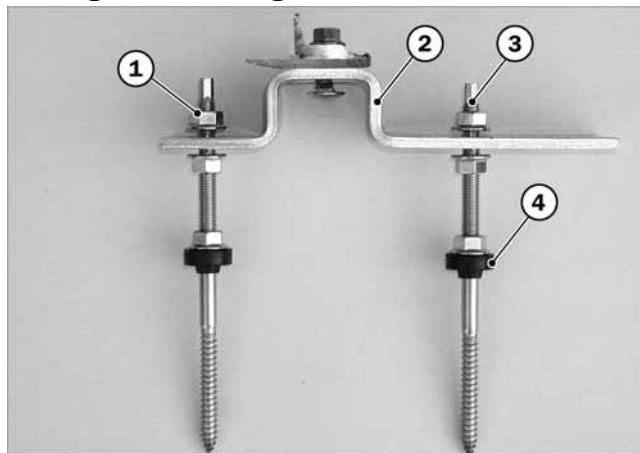

Afb. 61: Opbouw-dakbeugel ADH-W

- | | |
|------------------------------------|--------------------------------|
| 1 Moer, 6 stuks | 3 Stokschroef, 2 stuks |
| 2 Aluminium profiel met houderdeel | 4 Rubberen afdichting van EPDM |

Onderconstructie dak

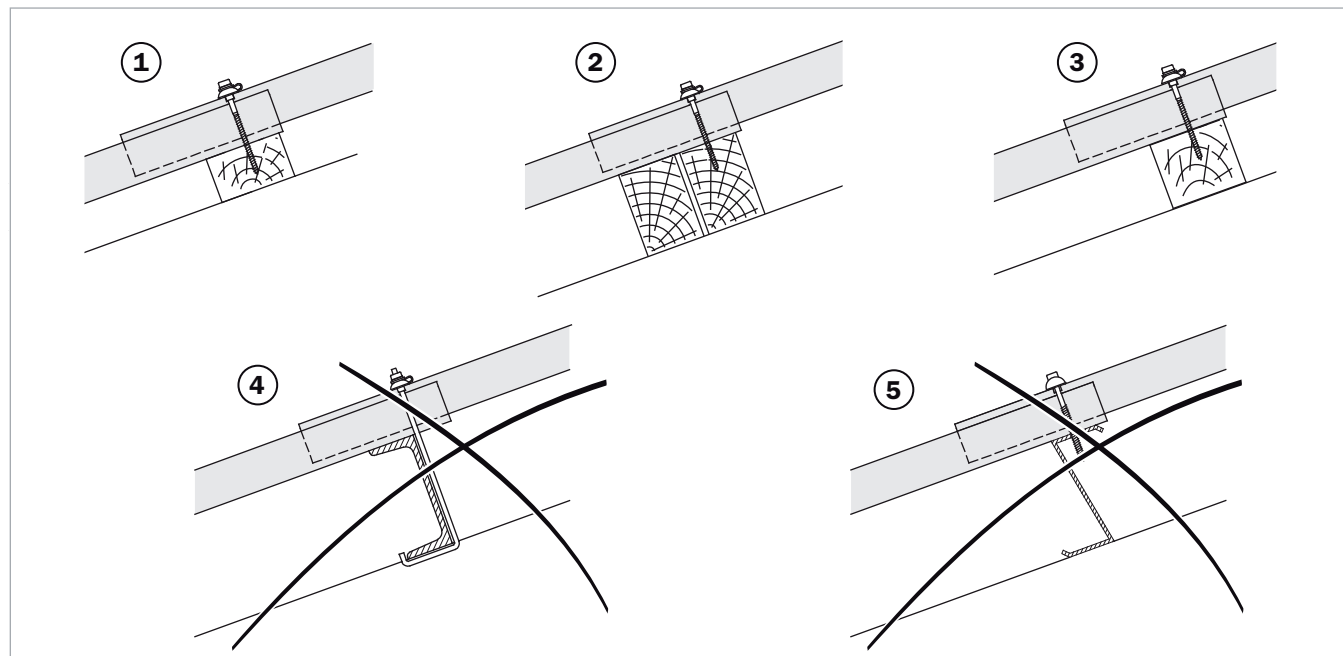

Afb. 62: Positie van de stokschroeven

- | | |
|--------------------------------|--------------------------------------|
| 1 Lat op daksparren | 4 Stalen draagbalk (niet toegestaan) |
| 2 Koppellat op daksparren | 5 Gebogen plaatstalen draagprofiel |
| 3 Nokgording (min. 60 x 60 mm) | |

Montage

 Voor het aantal en de afstanden van de opbouw-dakbeugels, zie → *Montage-instructies voor de collector*.



ATTENTIE

Het hout te allen tijde voorboren

In andere gevallen kunnen er scheuren of spleten ontstaan.

- In latten, nokgordingen of daksparren: met 6 mm diameter voorboren
- In golfplaat een steenboor 13 mm gebruiken.

Drie methoden om de opbouw-dakbeugel te plaatsen:

- parallel met de dakspar, beide schroeven in de dakspar
- dwars op de dakspar, één schroef in de dakspar
- dwars op de dakspar, dakspar tussen 2 schroeven.

Opbouw-dakbeugel parallel met de dakspar monteren

1. Methode A: Beide stokschroeven in de dakspar schroeven, daarbij de EPDM-afdichting vastdraaien.

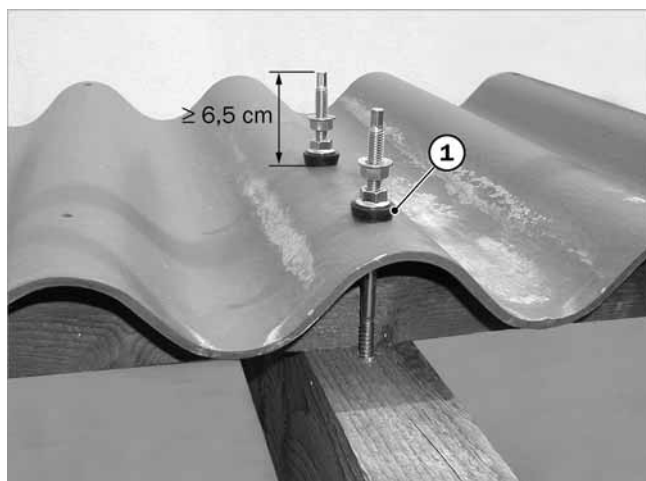

Afb. 63: Beide stokschroeven in de dakspar (methode A)

- 1 Afdichtend vastdraaien

2. Aluminium profiel met houderdeel monteren en in de hoogte richten.

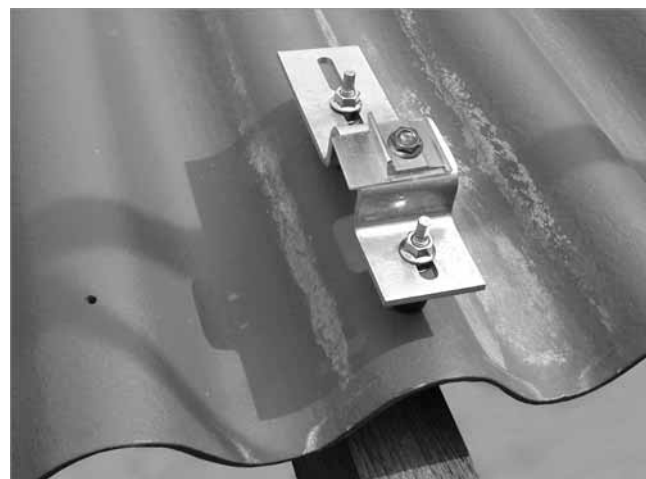

Afb. 64: Opbouw-dakbeugel gereed gemonteerd (methode A)

Opbouw-dakbeugel dwars op de dakspar monteren

1. Stokschroeven plaatsen, daarbij EPDM-afdichting vastdraaien. Methode B: één schroef in de dakspar en één daarnaast.

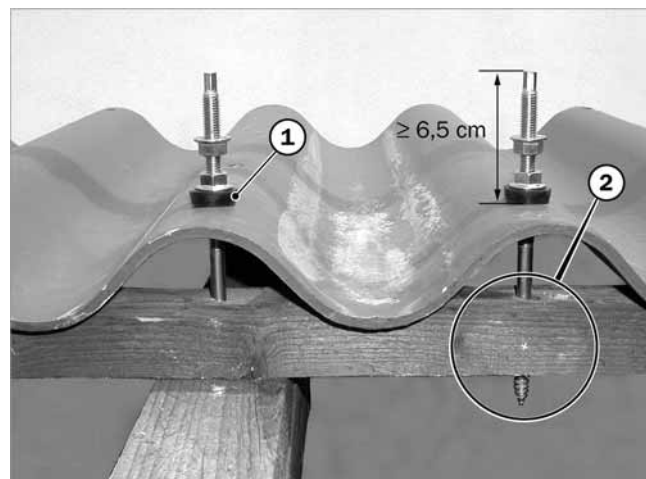

Afb. 65: Schroef 1 x in de dakspar, 1 x in de lat (methode B)

- 1 Afdichtend vastdraaien
- 2 Positie van de schroef → Afb. 68

2. Methode C: beide stokschroeven zo dicht mogelijk naast de dakspar plaatsen en afdichting vastdraaien.

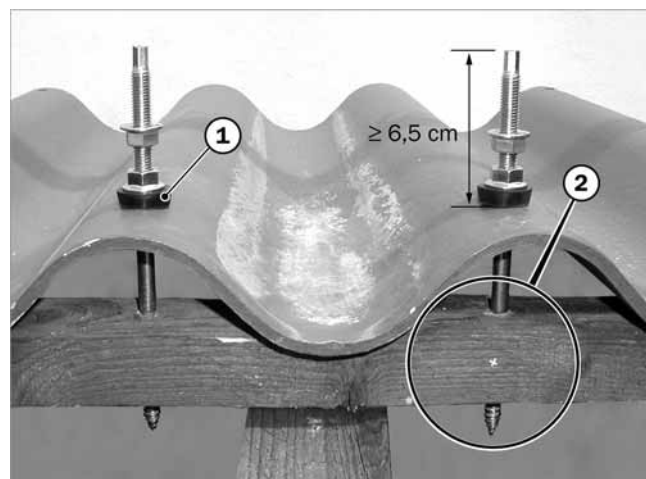

Afb. 66: Schroef 2 x in de lat of nokgording (methode C)

NL 1 Montage van Opbouw-dakbeugel ADH-W

- 1 Afdichtend vastdraaien
- 2 Positie van de schroef → Afb. 68
3. In geen enkel geval beide stokschroeven zodanig plaatsen, dat er zich geen dakspaar daartussenin bevindt.

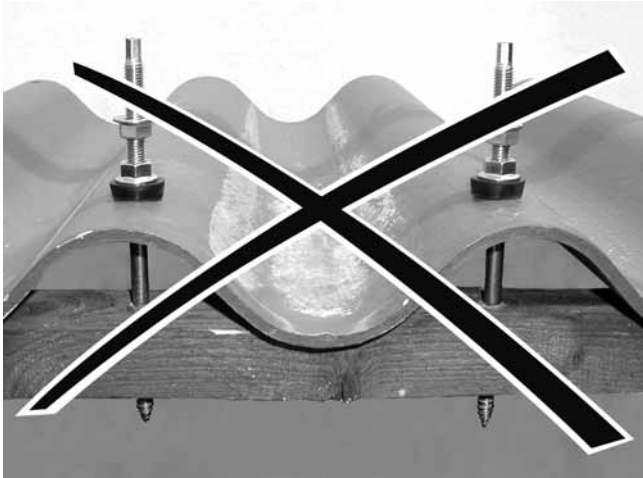

Afb. 67: **Verboden:** stokschroeven naast dakspaar geplaatst



ATTENTIE

Minimale hoogte in acht nemen

In andere gevallen is er niet voldoende draagcapaciteit gewaarborgd.

- De schroefdraad dient zich over de totale minimale hoogte in het hout te bevinden.
- Hoogte van de lat minimaal 40 mm!
- Hoogte van de nokgording minimaal 60 mm!

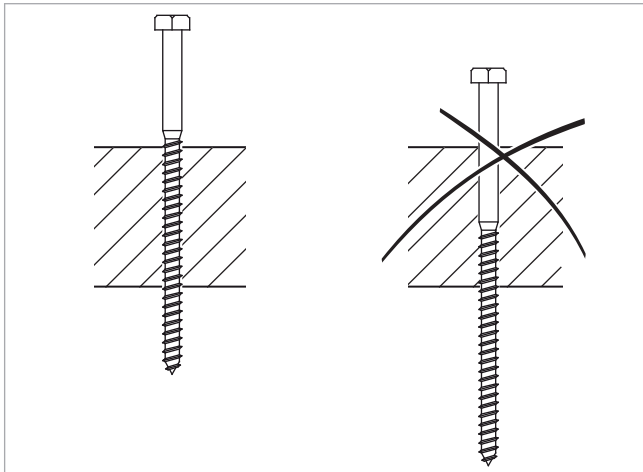

Afb. 68: Positie van de stokschroef in het hout

4. Aluminium profiel met houderdeel monteren en in de hoogte richten.



Afb. 69: Opbouw-dakbeugel gereed gemonteerd (methode B)

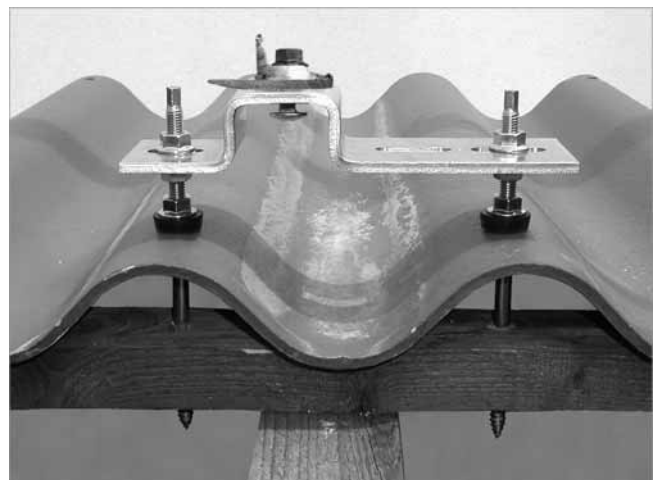

Afb. 70: Opbouw-dakbeugel gereed gemonteerd (methode C)



Verder met de montage van de klemrails, zie → montagehandleiding van de collector.

Notizen / Notes / Note / Notas / Notes / Notities

