

Creative Box 1000











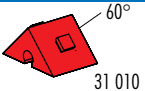
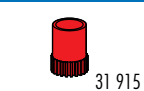
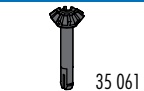

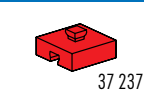

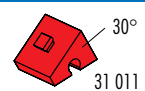
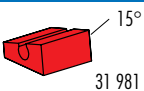

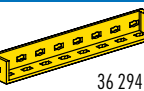
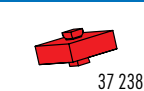



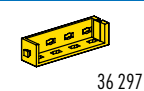

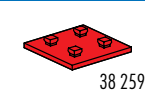

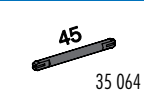

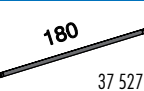

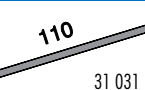
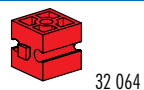
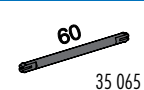

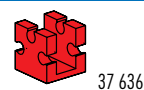
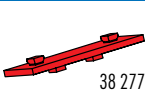
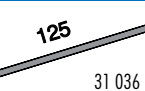
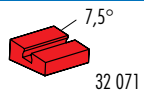
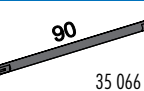
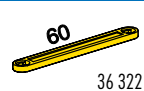
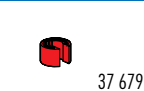
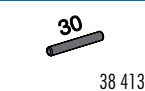
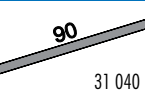
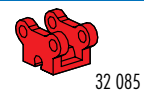

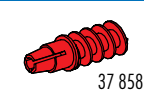
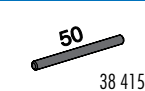

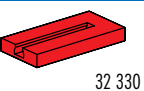

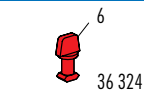
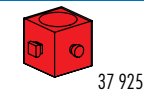
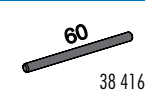
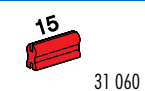
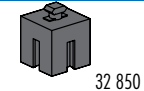
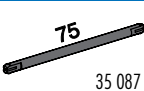
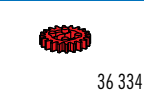

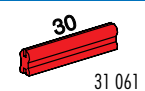
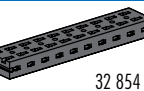
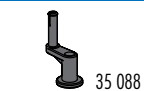
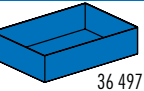

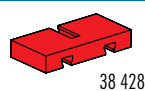
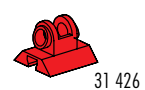
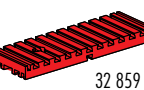
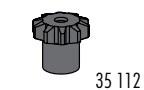
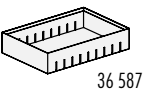
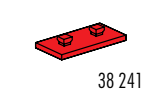
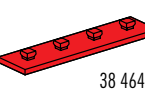
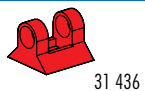
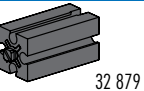

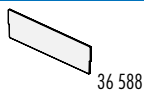
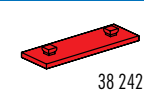

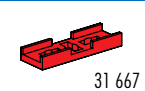
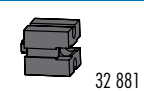
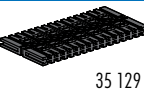
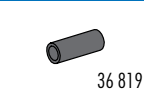
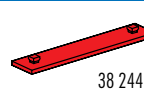
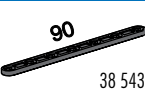
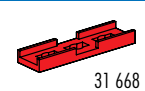
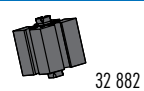
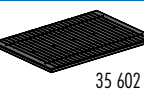
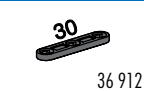
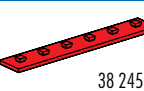
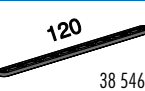
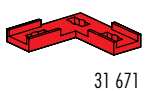
fischertechnik® 

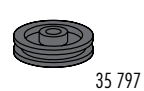
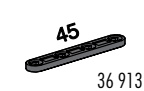
Einzelteilübersicht
Spare parts list
Liste des pièces détachées

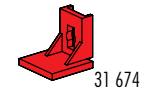
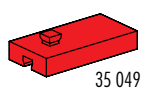
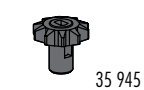
Onderdelenoverzicht
Lista da piezas
Resumo de peça individual

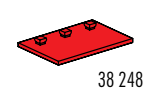
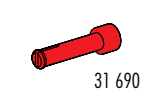

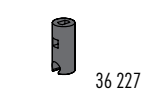
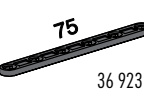
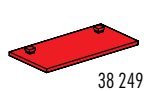
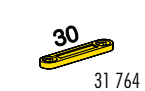
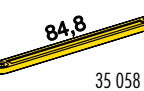
RO-BOTICA
ROBOTICA EDUCATIVA & PERSONAL

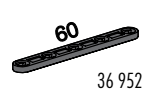
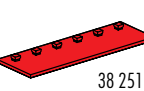
 31 010	6x	 31 915	1x	 35 061	2x	 36 264	1x	 37 237	10x	 38 253	2x
 31 011	6x	 31 981	4x	 35 062	2x	 36 294	8x	 37 238	10x	 38 258	2x
 31 021	2x	 31 982	20x	 35 063	2x	 36 297	4x	 37 468	10x	 38 259	2x
 31 022	1x	 31 983	4x	 35 064	2x	 36 298	4x	 37 527	1x	 38 260	2x
 31 031	1x	 32 064	10x	 35 065	2x	 36 299	4x	 37 636	4x	 38 277	2x
 31 036	1x	 32 071	4x	 35 066	2x	 36 322	12x	 37 679	20x	 38 413	4x
 31 040	1x	 32 085	1x	 35 073	6x	 36 323	108x	 37 858	1x	 38 415	2x
 31 058	4x	 32 330	4x	 35 076	4x	 36 324	20x	 37 925	1x	 38 416	2x
 31 060	20x	 32 850	4x	 35 087	2x	 36 334	20x	 37 926	2x	 38 423	10x
 31 061	10x	 32 854	2x	 35 088	1x	 36 497	1x	 38 240	4x	 38 428	2x
 31 426	2x	 32 859	2x	 35 112	1x	 36 587	8x	 38 241	8x	 38 464	4x
 31 436	4x	 32 879	20x	 35 113	1x	 36 588	16x	 38 242	4x	 38 542	16x
 31 667	2x	 32 881	10x	 35 129	2x	 36 819	3x	 38 244	2x	 38 543	4x
 31 668	2x	 32 882	8x	 35 602	1x	 36 912	4x	 38 245	4x	 38 546	4x
 31 671	2x	 35 031	4x	 35 797	2x	 36 913	4x	 38 246	4x		
 31 674	4x	 35 049	4x	 35 945	2x	 36 914	4x	 38 248	2x		
 31 690	4x	 35 053	4x	 36 227	4x	 36 923	4x	 38 249	2x		
 31 764	8x	 35 058	16x	 36 248	102x	 36 952	4x	 38 251	4x		

Montagehilfen und Hinweise
 Assembly aids and instructions
 Aides de montage et instructions

Montagehulpmiddelen en aanwijzingen
 Ayudas de montaje e instrucciones
 Montagens e indicações

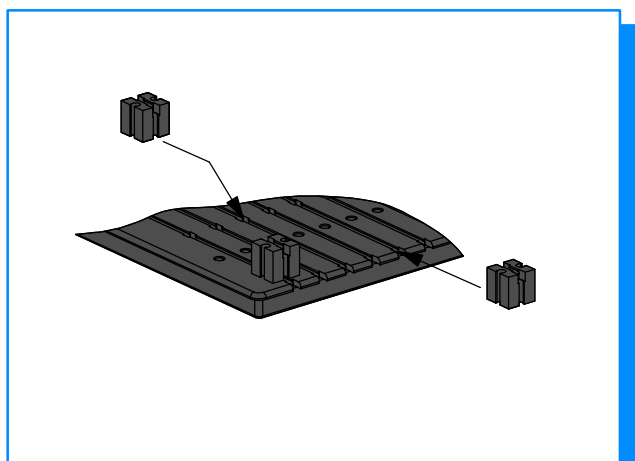
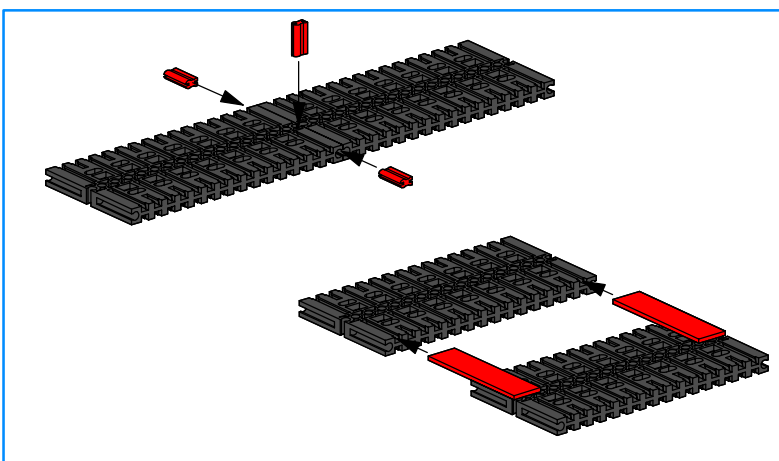
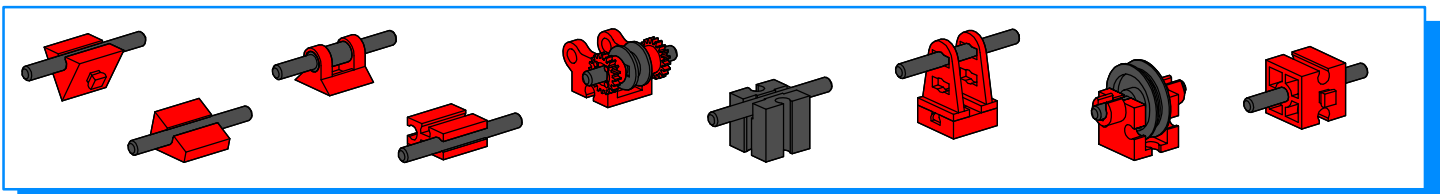
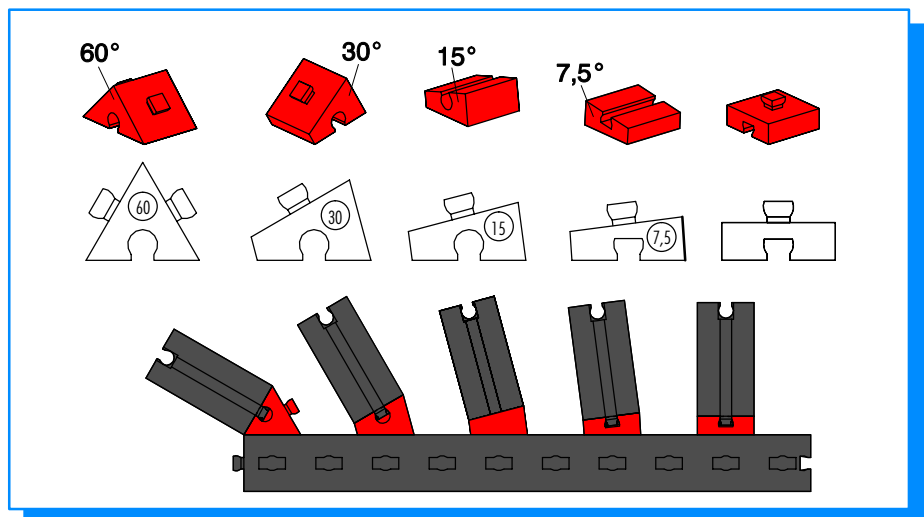
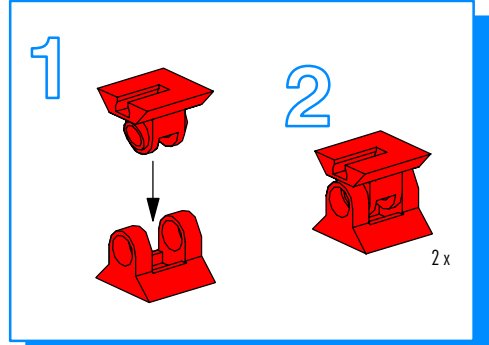
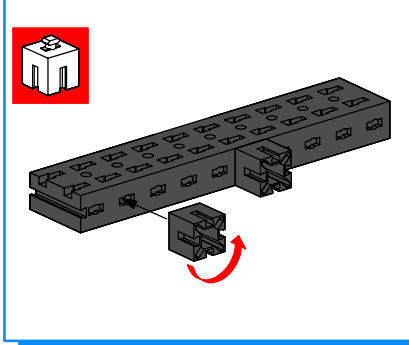
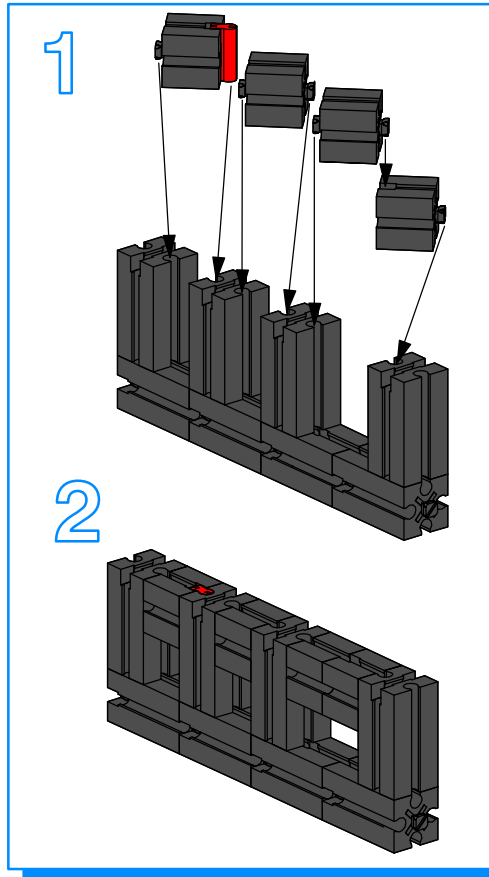
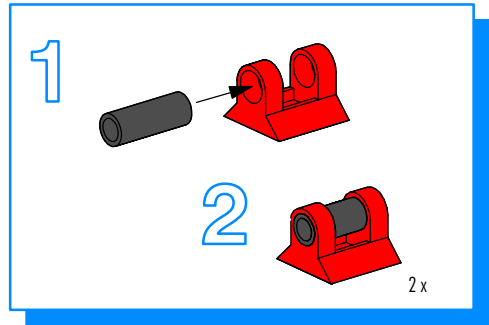
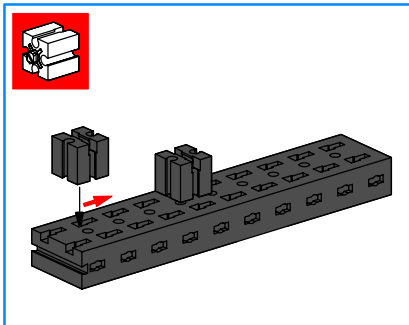
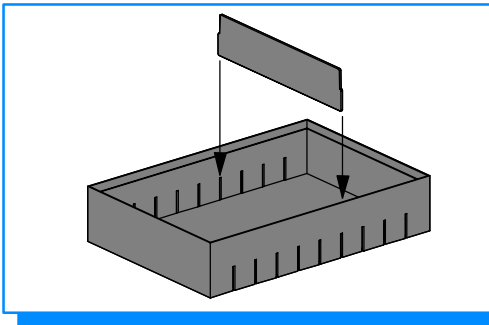

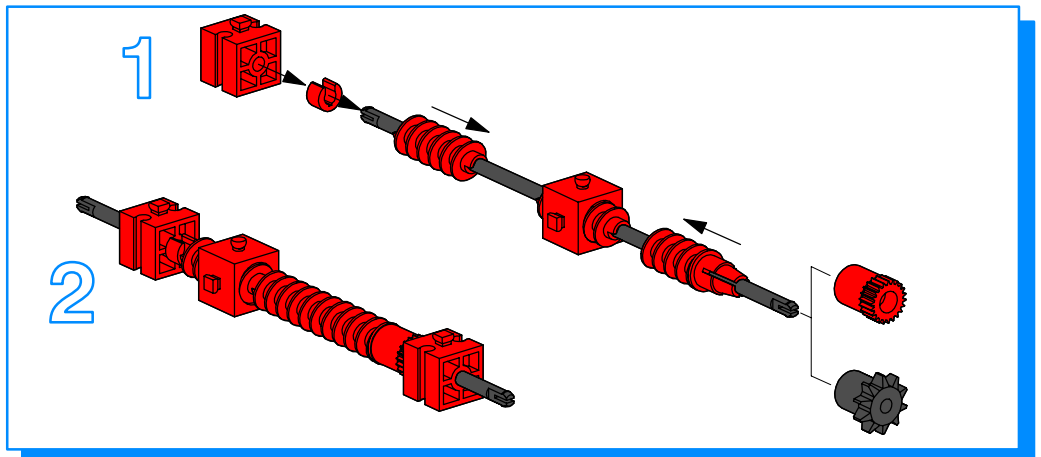
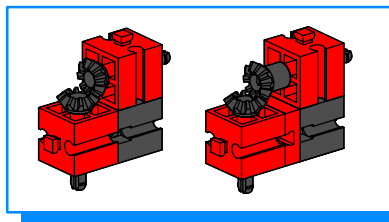
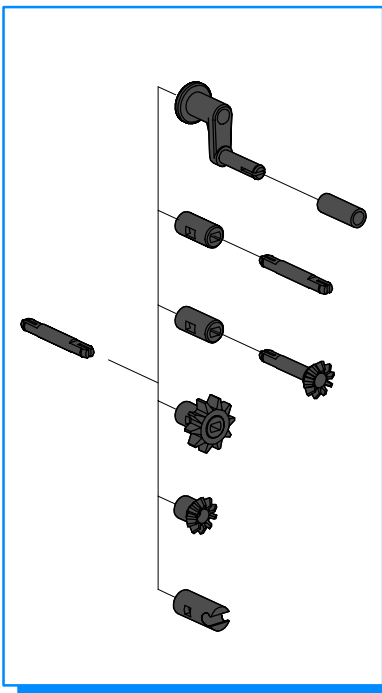
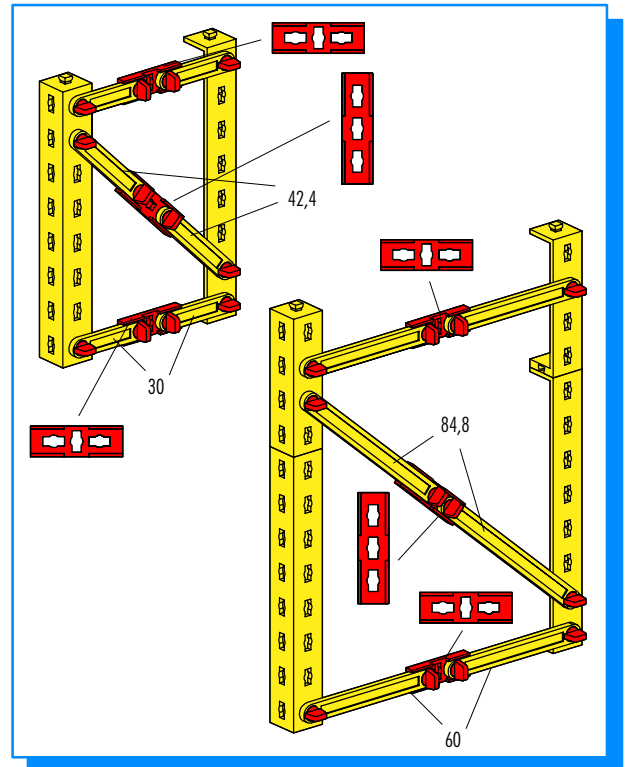
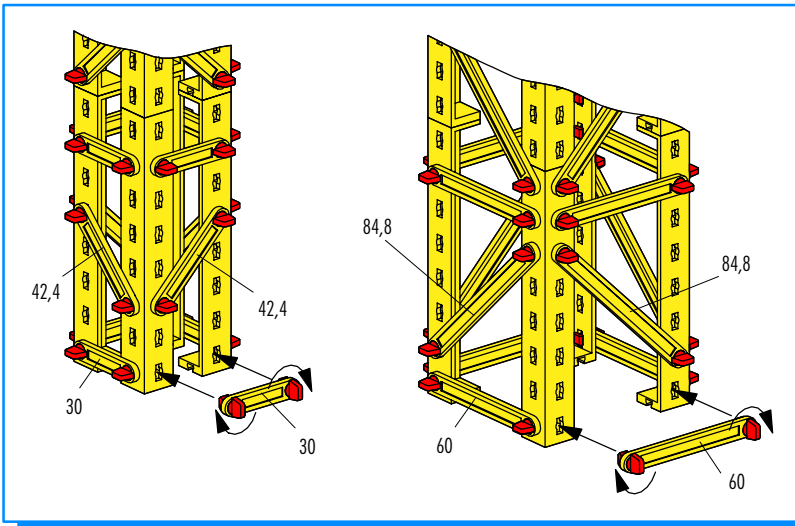
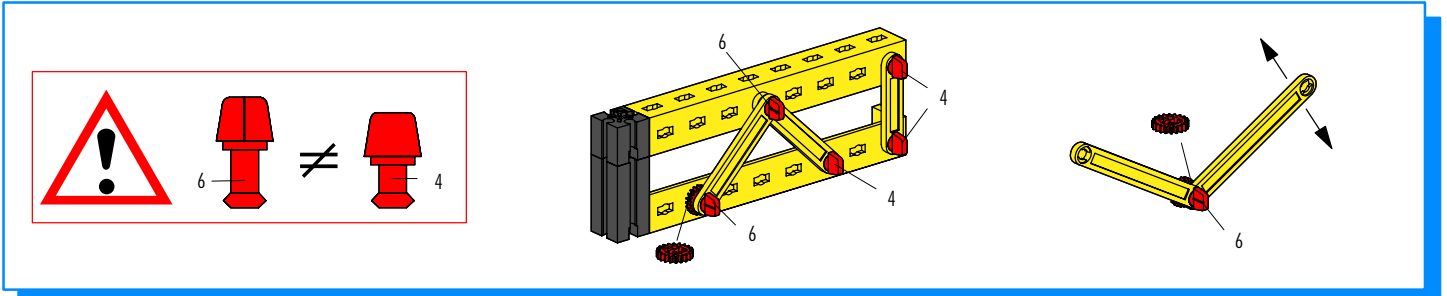
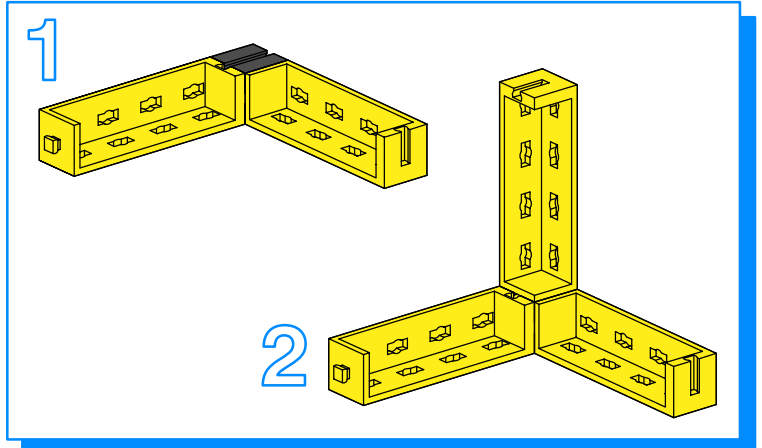
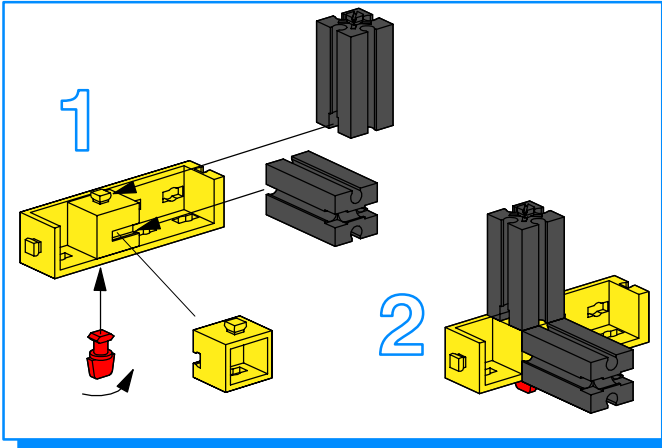

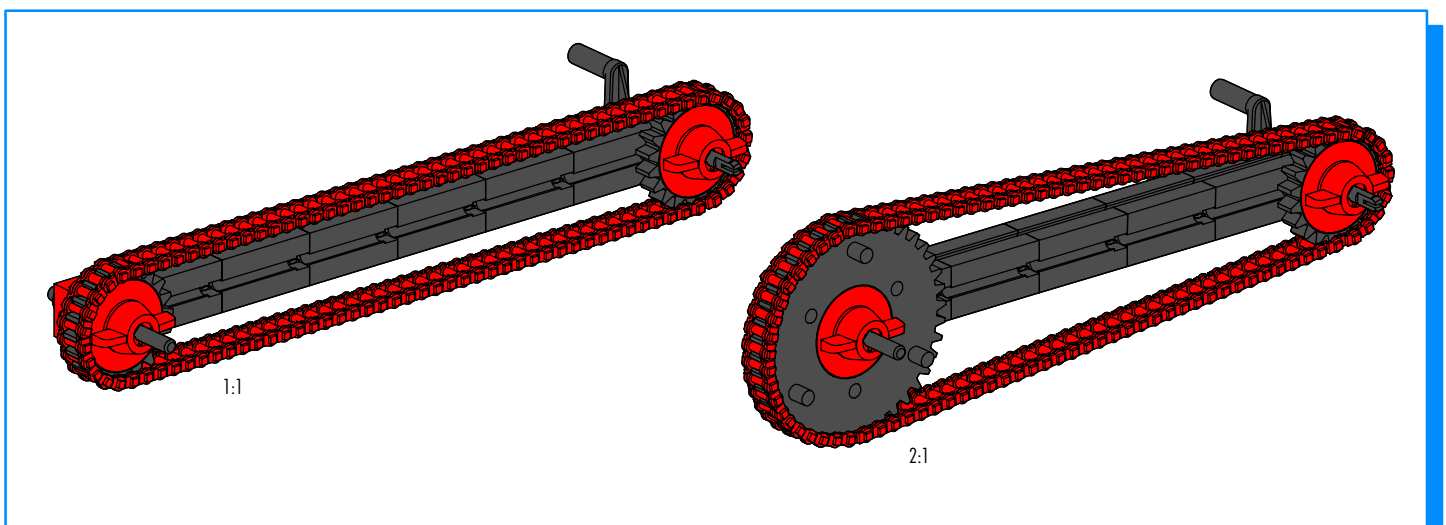
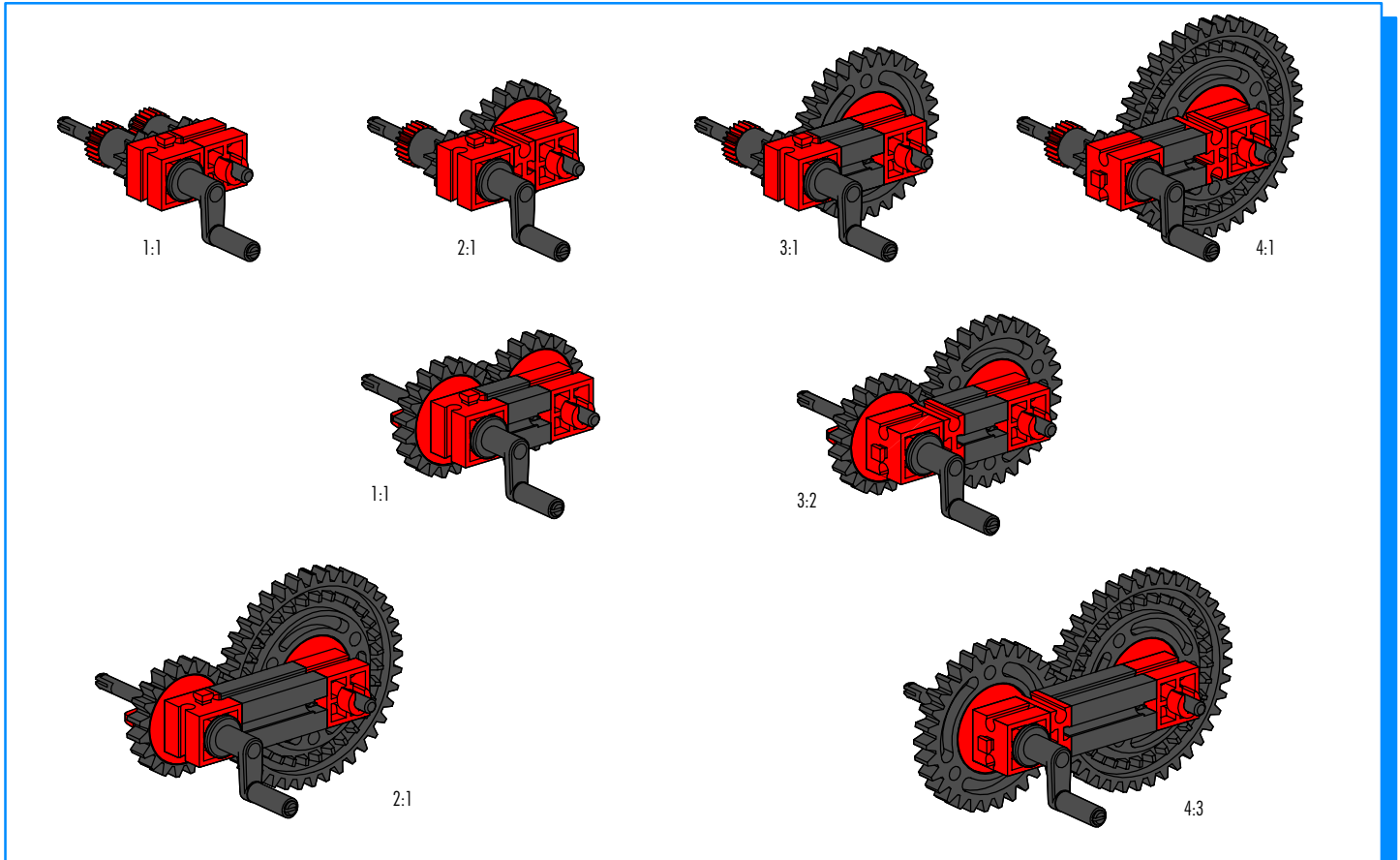
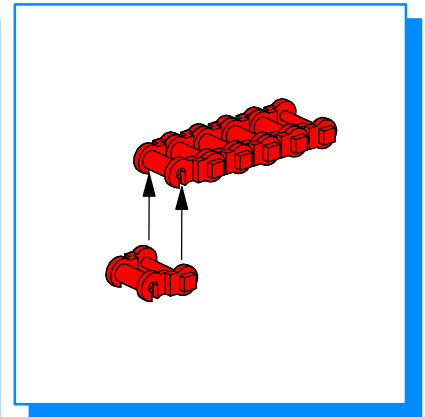
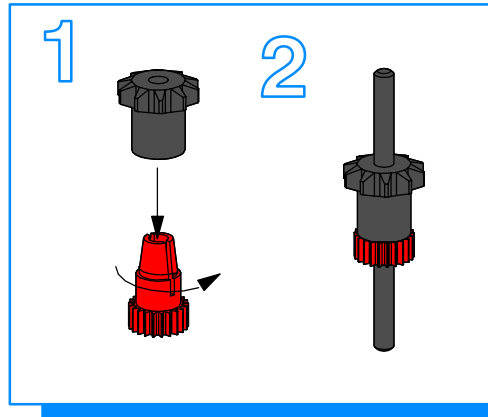
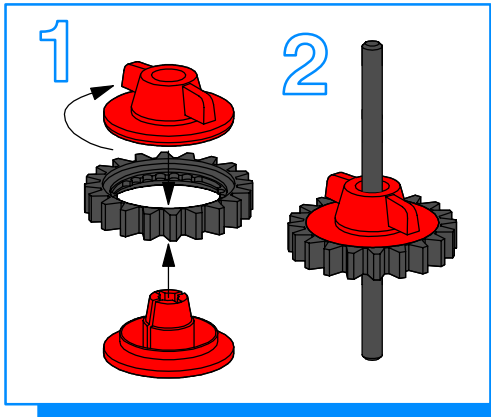

■ Alle Einzelteile, insbesondere bewegliche Teile sind falls notwendig zu warten und zu reinigen.
 ■ All components, especially moving parts, should be maintained and cleaned as necessary.
 ■ Toutes les pièces détachées et en particulier les pièces mobiles, sont, si nécessaire, à entretenir et à nettoyer.

■ Alle onderdelen, vooral de bewegende delen, kunnen, indien noodzakelijk, onderhouden en gereinigd worden.
 ■ Es necesario limpiar y mantener en buen estado todas las diferentes piezas - especialmente las piezas móviles.
 ■ Caso necessário, todas as peças individuais, especialmente peças móveis, tem que ser submetidas à manutenção e ser limpas.