

User Manual

Predia Touch Pro

The logo for Predia, featuring the word "predia" in a white, lowercase, sans-serif font with a modern, slightly rounded appearance. The logo is centered on a dark blue background that has a curved orange shape on the left side.

Before connecting, operating or adjusting this product, please read the manual completely.
Please keep this manual for future reference.

CONTENTS

Important Information	1
Important Safety Precautions	2
Identification of Controls	4
Remote Control	6
Getting Started	7
Connections	8
Basic Operations	9
Operating the Menu	10
User Menu List	11
Annotation	15
WhiteBoard	16
File Explorer	17
Wireless Cast	18
Visualizer	19
Troubleshooting	20
Specifications	21

IMPORTANT INFORMATION

If the LED is not positioned in a stable location, it can be potentially hazardous due to falling. Many injuries, particularly to children, can be avoided by taking simple precautions such as:

- Use cabinets or stands recommended by the manufacturer of the LED.
- Only use furniture that can safely support the LED.
- Ensure the LED is not hanging over the edge of the supporting furniture.
- Do not place the LED on tall furniture (for example, cupboards or bookcases) without anchoring both the furniture and the LED to a suitable support.
- Do not position the LED on cloth or place any material between the LED and supporting furniture.
- Increase children's awareness of danger caused by falling down of the LED, or being hurt by bumping into the LED.
- Do not use immediately after moving from a low temperature to high temperature environment, as this causes condensation, which may result in fire, electric shock, or other hazards.
- To avoid possible condensation it is recommended to not use the device within 24 hours after its arrival, to avoid possible condensation.

Warning:

To prevent the spread of fire, keep candles or other open flames away from the LED at all times.

IMPORTANT SAFETY PRECAUTIONS



This symbol indicates that dangerous voltage instituting a risk of electric shock is present within this unit.



This symbol indicates that there are important operation and maintenance instructions in the literature accompanying the appliance.

Electricity may cause personal injuries and property damage if handled improperly. The LED has been engineered and manufactured with the highest priority on safety. But IMPROPER USE CAN RESULT IN POTENTIAL ELECTRIC SHOCK OR FIRE HAZARD. In order to prevent potential danger, please observe the following instructions when installing, operating and cleaning the product. To ensure your safety and prolong the service life of your LED, please read the following precautions carefully before using the product.

- 1. Read these instructions**---All operating instructions must be read and understood before the product is used.
- 2. Keep these instructions**---These safety and operating instructions must be kept in a safe place for future reference.
- 3. Note all warnings**---All warnings on the product and in the instruction manual must be observed closely.
- 4. Follow all instructions**---All operating instructions must be followed.
- 5. Attachments**---Only use attachments/accessories specified by the manufacturer. Do not use attachments which are not recommended by the manufacturer. Use of improper attachments can result in accidents.
- 6. Power source**---This product is intended to be supplied with a listed power supply indicated on the marking label. If you are not sure of the type of power supply at your location, consult your product dealer or local power company. For added protection for this product during a lightning storm, or when it is left unattended and unused for a long period of time, unplug it from the wall outlet and disconnect the cable system.
- 7. Power cord protection**---Protect the power cord from being walked on or pinched particularly at plugs, wall outlet, and the point where they exit from the device.
NOTE: Where the mains plug or an appliance coupler is used as the disconnected device, the disconnected device shall remain readily operable.
- 8. Overloading**---Do not overload wall outlets, extension cords, or convenience receptacles on other equipment as this can result in a risk of fire or electric shock.
- 9. Entering of objects and liquids**---Never insert an object into the product through vents or openings. High voltages are present in the product and inserting an object can cause electric shock and/or short circuit internal parts. For the same reason, do not spill water or liquid on the product.

10. Servicing---Refer all servicing to qualified service personnel. Servicing is required when the device has been damaged in any way, such as the power-supply cord or plug is damaged, liquid has been spilled, objects have fallen into the device, the device has been exposed to rain or moisture, does not operate normally or has been dropped.

11. Damage requiring service---If any of the following conditions occurs, unplug the power cord from the AC outlet and request a qualified service technician to perform repairs.

- When the power cord or plug is damaged.
- When liquid is spilled on the product or when objects have fallen into the product.
- When the product has been exposed to rain or water.
- When the product does not operate properly as described in the operating instructions.

Do not touch the controls other than those described in the operating instructions. Improper adjustment of controls not described in the instructions can cause damage, which often requires extensive adjustment work by a qualified technician.

e. If the product has been dropped or the cabinet has been damaged in any way.

f. When the product displays an abnormal condition or exhibits a distinct change in performance. Any noticeable abnormality in the product indicates that the product needs servicing.

12. Replacement parts---In case the product needs replacement parts, make sure that the service person uses replacement parts specified by the manufacturer, or those with the same characteristics and performance as the original parts. Use of unauthorized parts can result in fire, electric shock and/or other danger.

13. Safety checks---Upon completion of service or repair work, request the service technician to perform safety checks to ensure that the product is in proper operating condition.

14. Wall or ceiling mounting---When mounting the device on a wall or ceiling, be sure to install the product according to the method recommended by the manufacturer. This is a safety issue.

15. Stand---Use only with the trolley, stand or wall mount specified through CE/UL/GS safety certificate. or sold with the device. Do not place the product on an unstable trolley, stand. Placing the product on an unstable base can cause the product to fall, resulting in possible serious injuries as well as damage to the device.

16. Careful move---When a trolley is used, be cautious when moving the trolley/device combination to avoid injury from the device tipping over. Sudden stops, excessive force and uneven floor surfaces can cause the product to fall from the trolley.

Careful move and be careful please, point of strength should not in display screen.

Never attempt to move the LED unless the AC power cord has been disconnected.

17. Do not use this device near water---for example, near a bathtub, washbowl, kitchen sink, laundry tub, in a wet basement or near a swimming pool, and the like.

IMPORTANT SAFETY PRECAUTIONS

The apparatus should not be exposed to dripping or splashing liquids and that no objects filled with liquids, such as vases, shall be placed on the apparatus.

Do not use immediately after moving from a low temperature to high temperature environment, as this causes condensation, which may result in fire, electric shock, or other hazards.

18.Clean only with dry cloth---Unplug the device from the power before cleaning. Do not use liquid cleaners or aerosol cleaners. Use a soft cloth for cleaning.

19.Ventilation---Do not block any ventilation openings. Install the LED in accordance with the manufacturer instructions. Do not cover or block these vents and openings since insufficient ventilation can cause overheating and/or shorten the life of the product. This product is not designed for built-in installation; therefore do not place the product in an enclosed space such as a bookcase or rack, unless proper ventilation is provided or the manufacturer's instructions are followed.

It should have interspace around the product and the wider it has the heat dissipation is better. Suggest up>10cm, around>10cm and back >2.5cm.

20.Heat sources---Do not install near any heat sources such as radiators, heat registers, stoves, or other device (including amplifiers) that produce heat.

21.Panel protection---The display panel used in this product is made of glass. Therefore, it can break when the product is dropped or impacted upon by other objects. Be careful not to be injured by broken glass pieces in case the display panel breaks.

Do not use hard or sharp object to take place of special pen when write in the screen.

Wipe the screen from one side to the other carefully till it looks completely clean. Do not flailing in all directions.

22.Pixel defect---The display panel is a very high technology product, giving you fine detailed pictures. Occasionally, a few non-active pixels may appear on the screen as a fixed point of blue, green or red. Please note that this does not affect the performance of your product.

WARNING: For continued safety, device with class I construction shall be connected to a mains socket outlet with a protective earthing connection.

Environmental Protection

Waste electrical products should not be disposed of with household waste. Please recycle where facilities exist. Check with your Local Authority or retailer for recycling advice.



About Location/Environment

Do not use in hot and cold rooms (locations)

- When the unit is used in rooms (locations) with low temperature, the picture may leave trails or appear slightly delayed. This is not a malfunction. The unit will recover when the temperature returns to normal.
- Do not leave the unit in a hot or cold location. Also, do not leave the unit in a location exposed to direct sunlight to near a heater or in high humidity, as this may cause the cabinet to deform and the LED to malfunction and affect the LED's performance.
- Environment condition:
 - Operating temperature: 5°C – 35°C
 - Operating humidity: 20% – 80% (no moisture condensation)
 - Storage temperature: -15°C – 45°C
 - Storage humidity: 10% – 80%
 - Atmospheric pressure: 86 kPa ~106 kPa

About After-Image

The extended use of fixed image program material can cause a permanent after-image on the screen.

This background image is viewable on normal programs in the form of a stationary fixed image. This type of irreversible screen deterioration can be limited by observing the following steps:

- Reduce the brightness/contrast setting to a minimum viewing level.
- Do not display the fixed image for extended periods of time.
- Turn the power off when the display is not in actual use.

Important Information Regarding Use of Video Games, Computers, Captions or Other Fixed Image Displays.

- Do not allow a still picture to be displayed for an extended period of time, as this can cause a permanent after-image to remain on the screen. Examples of still pictures include logos, video games, computer images, teletext and images displayed in 4:3 mode.

CAUTIONS:

- The permanent after-image on the screen resulting from fixed image use is not an operating defect and as such is not covered by the warranty.
- This product is not designed to display fixed images for extended periods of time.
- It is not advised to put the screen in portrait mode because this will affect the warranty.

Cleaning and Maintenance

To clean this unit, wipe with a soft, dry cloth.

Clean the cabinet with a soft, lint-free cloth. If the cabinet is especially dirty, moisten a soft, lint-free cloth in a weak detergent Solution, squeeze the excess moisture from the cloth, then wipe the cabinet with the cloth. Use a clean cloth to dry the cabinet.

- Use eyeglass cleaner to remove stubborn dirt from the LED.
- Never use alcohol, paint thinner or benzine to clean this device.

Carrying or Moving the LED

- When you move the LED, hold the frame of the LED.
- Be aware of the danger or harm which may be caused by carrying or moving the LED, as the bezel is very thin.
- When transporting, do not subject the unit to shocks or vibration, or excessive force.

IDENTIFICATION OF CONTROLS

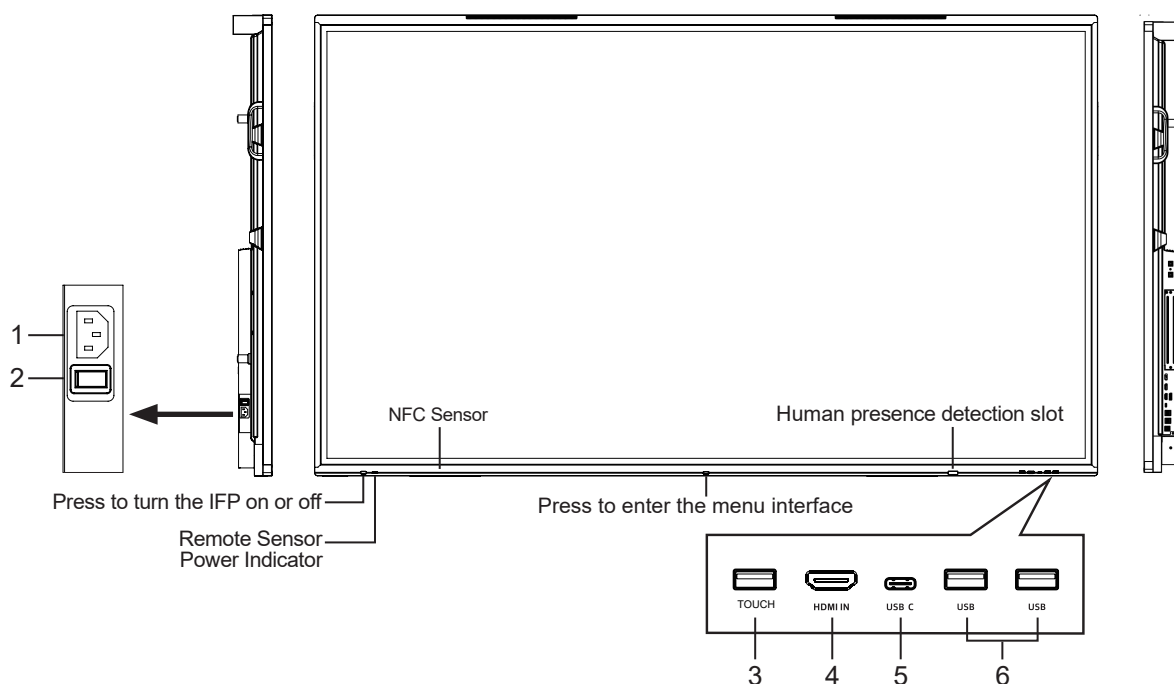

1	AC IN	Plug the AC cord into this jack and into a power outlet. (AC 100-240V 50/60Hz)
2	Power Switch	Push (I) to connect the power, push (O) to cut off the power. Note: Don't cover the power switch.
3	TOUCH	Connect an external device to support touch control of the external device on the IFP.
4	HDMI IN	Connect an HDMI or DVI device to this jack.
5	USB C	Full - featured Type C.
6	USB	Connect USB devices to this port.

IDENTIFICATION OF CONTROLS

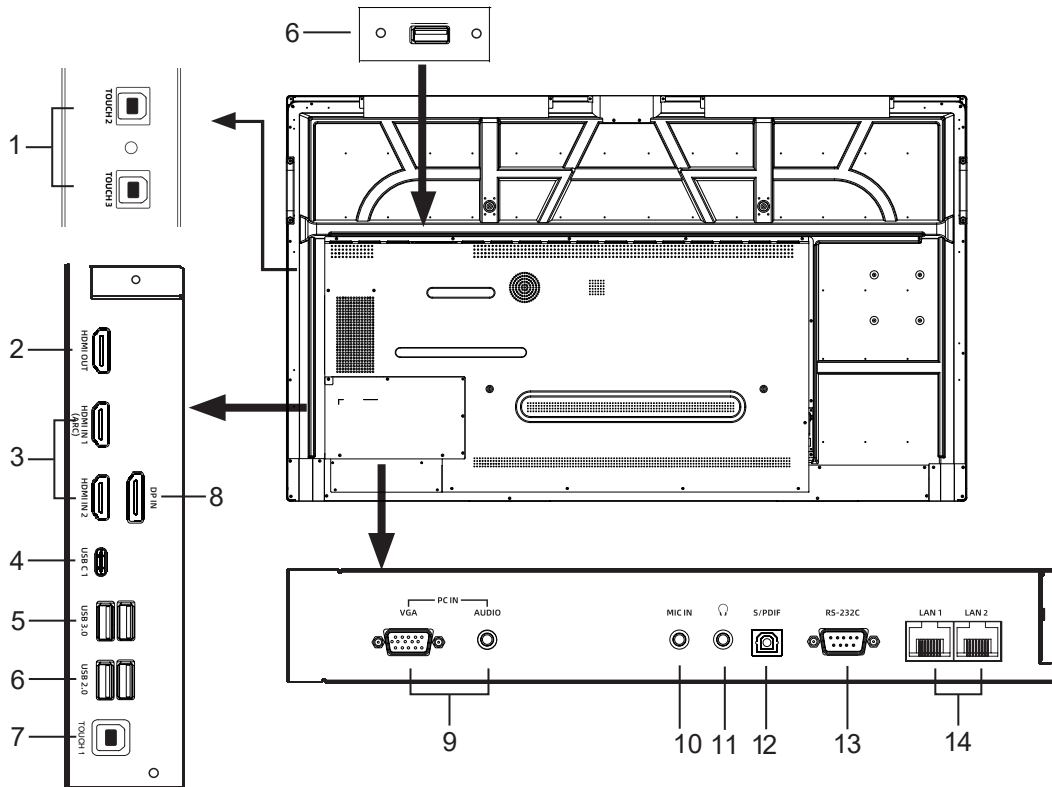

1 TOUCH 2/3	Connect an external device to support touch control of the external device on the screen.
2 HDMI OUT	Connect an external device with a HDMI cable to this port to output the image and sound of the screen.
3 HDMI IN 1/2	Connect an external device with a HDMI cable to this port.
4 USB C 1	PD 65W, 5V = 3A, 9V = 3A, 15V = 3A, 20V = 3.25A Connect an external device with an USB-C cable to this port.
5 USB 3.0	5V = 0.9A Connect USB devices to this port.
6 USB 2.0	5V = 0.5A Connect USB devices to this port. Note: It must be used if you upgrade software.
7 TOUCH 1	Connect an external device to support touch control of the external device on the screen.
8 DP(DisplayPort) IN	Connect an external device to DP out jack.
9 PC IN	Connect the video/audio of a computer to these ports.
10 MIC IN	The microphone jack.
11 	Connect headphones to this jack. The screen is the current audio output.
12 S/PDIF digital audio output	Connect a digital sound system to this jack.
13 RS 232C	For remote control, service and other uses.
14 LAN 1/2	Connects the external network or the router.

REMOTE CONTROL

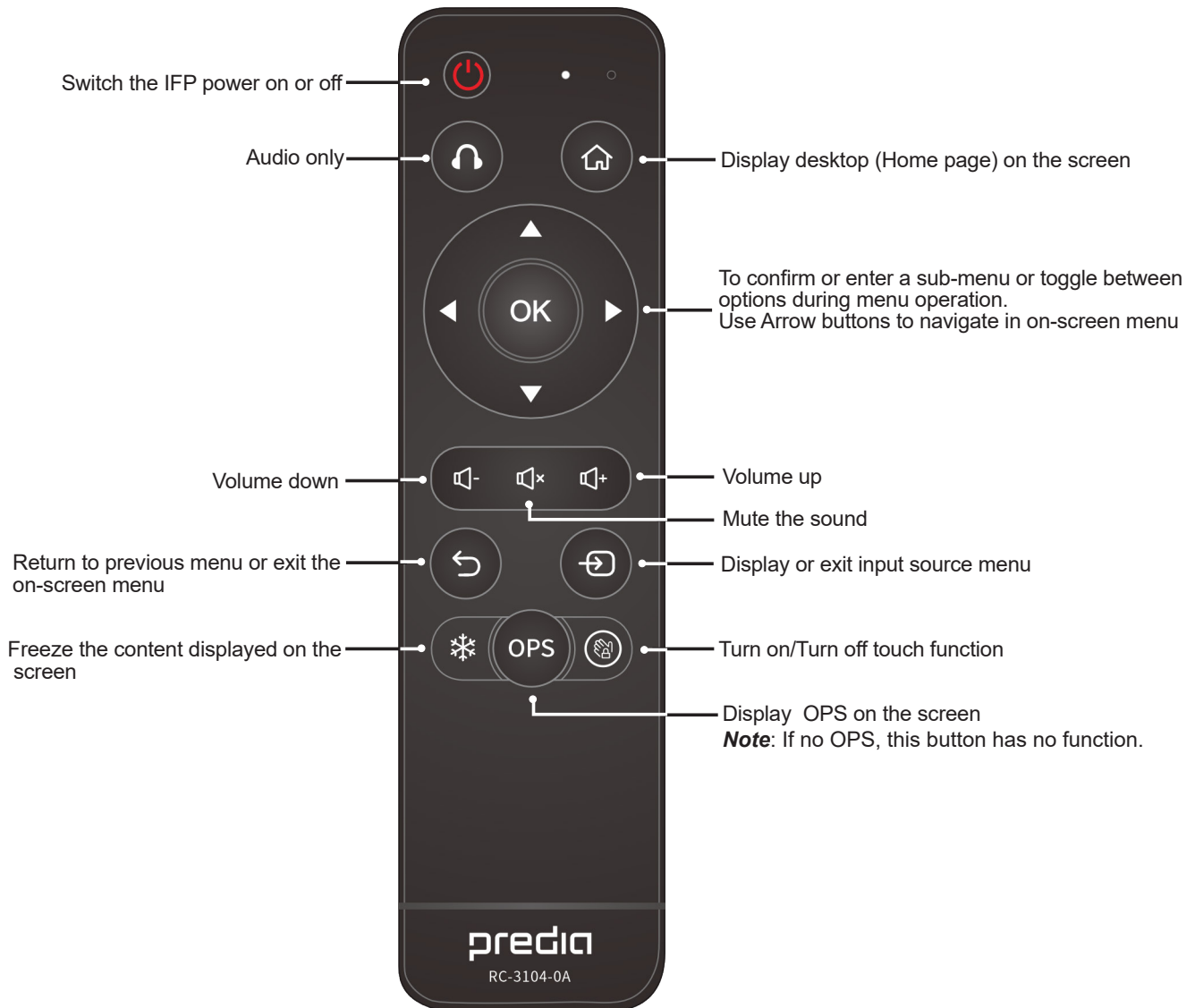

NOTES:

- This operation manual provides a description based on operating functions with the remote control.
- In different mode, some buttons may have different function.

GETTING STARTED

Installation of the OPS



Warning: Please cut off power before the OPS can be plugged in and out, no hot plug.

Installation instructions

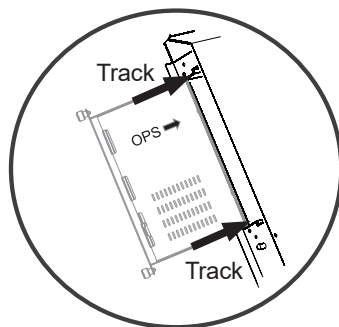
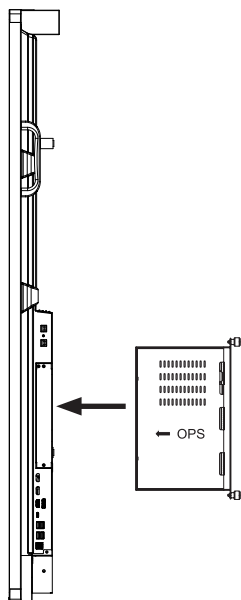

1. Insert the OPS into the slot along the track on both sides.

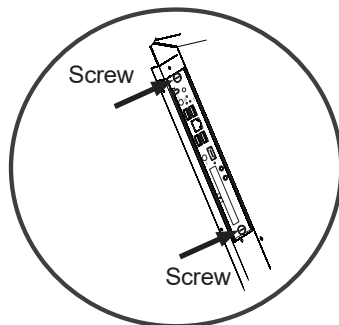

2. Fasten the OPS with two screws provided on the side frame.

CONNECTIONS

Cautions Before Connecting

- When connecting an external device to the screen, make sure that the screen and the external device are turned off.
- Check the plugs at the ends of the cables to make sure that they are the correct type before plugging them into the jacks on the screen.
- Make sure that all plugs are securely inserted into the jacks. Loose connections can result in image or color problems.
- The illustration of the external device may be different depending on your model.
- Refer to the operating manual of the external device as well.

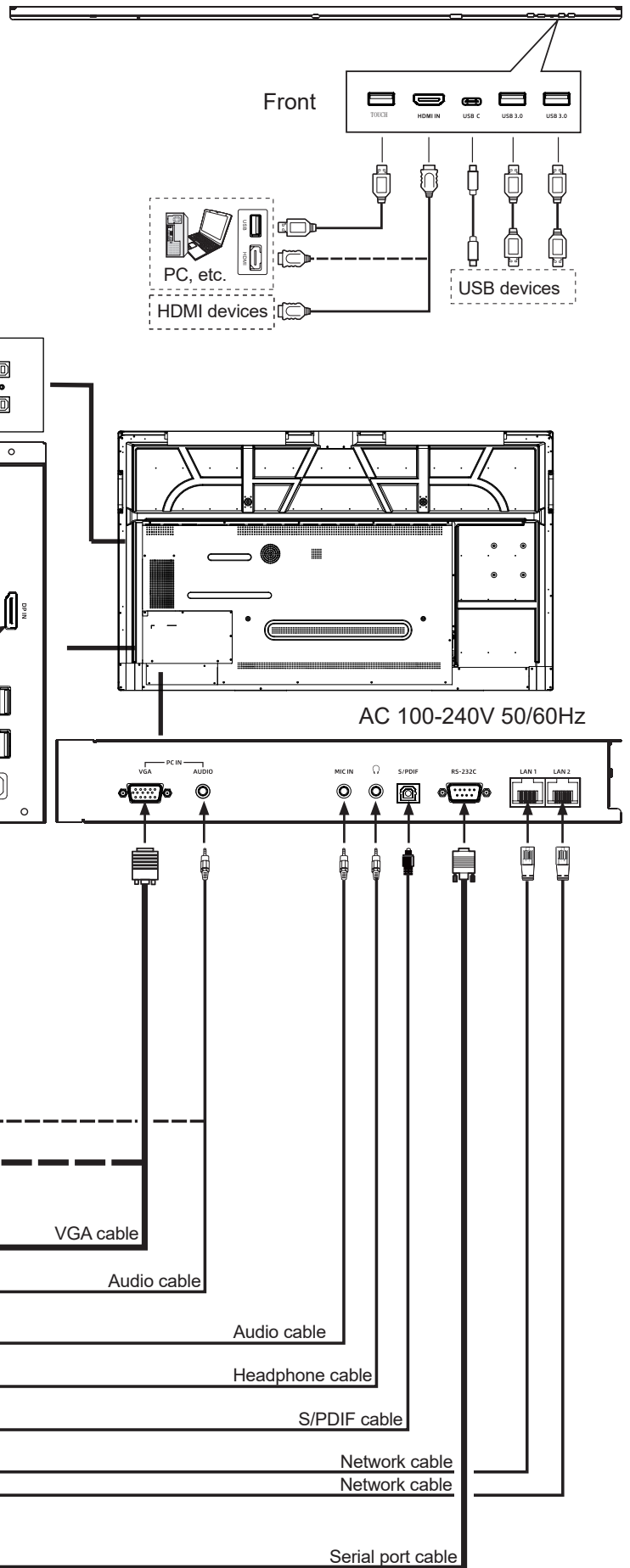



Connect TOUCH with USB cable to PC USB port.
 Connect PC with VGA cable, HDMI cable or DP cable.
 Please choose the proper method of connection based on your device. (Only for PC, HDMI, DP signal)
 Touch 1 corresponds to the HDMI 1, HDMI 2, DP or VGA

Note: Before using headphones, adjust the device volume to avoid excessive volume, as hearing damage may result. www.predia.eu

BASIC OPERATIONS

Turning the LED on or off

1. Plug the power cord into an AC power outlet.
2. Press Power Switch on the LED.
3. Now the LED is in standby mode. Wait a moment until the power indicator lights up, then press  button to turn on the LED.

Note: Be sure to wait for a few seconds before pressing  button. If you promptly press  button then the LED may not respond or act wrongly.

4. Press  button again to turn off the LED and put the display in standby mode.
5. To cut off the power completely, press Power Switch on the back of the LED.

FIRST TIME INSTALLATION

When turning on the LED for the first time, the below shown installation menu pages will appear on the screen.

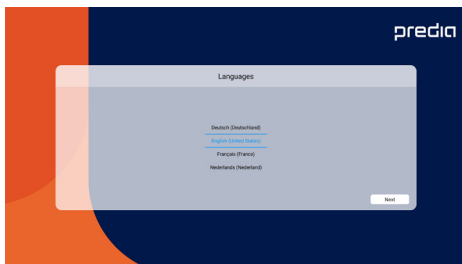

Select the desired menu language, press **Next** to go to the next page.

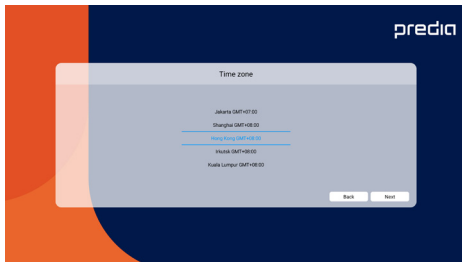

Select the Time Zone, press **Next** to go to the next page.

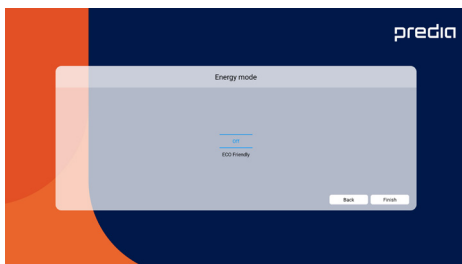

Select the Energy mode, press **Finish** to finish the installation.

OPERATING THE MENU

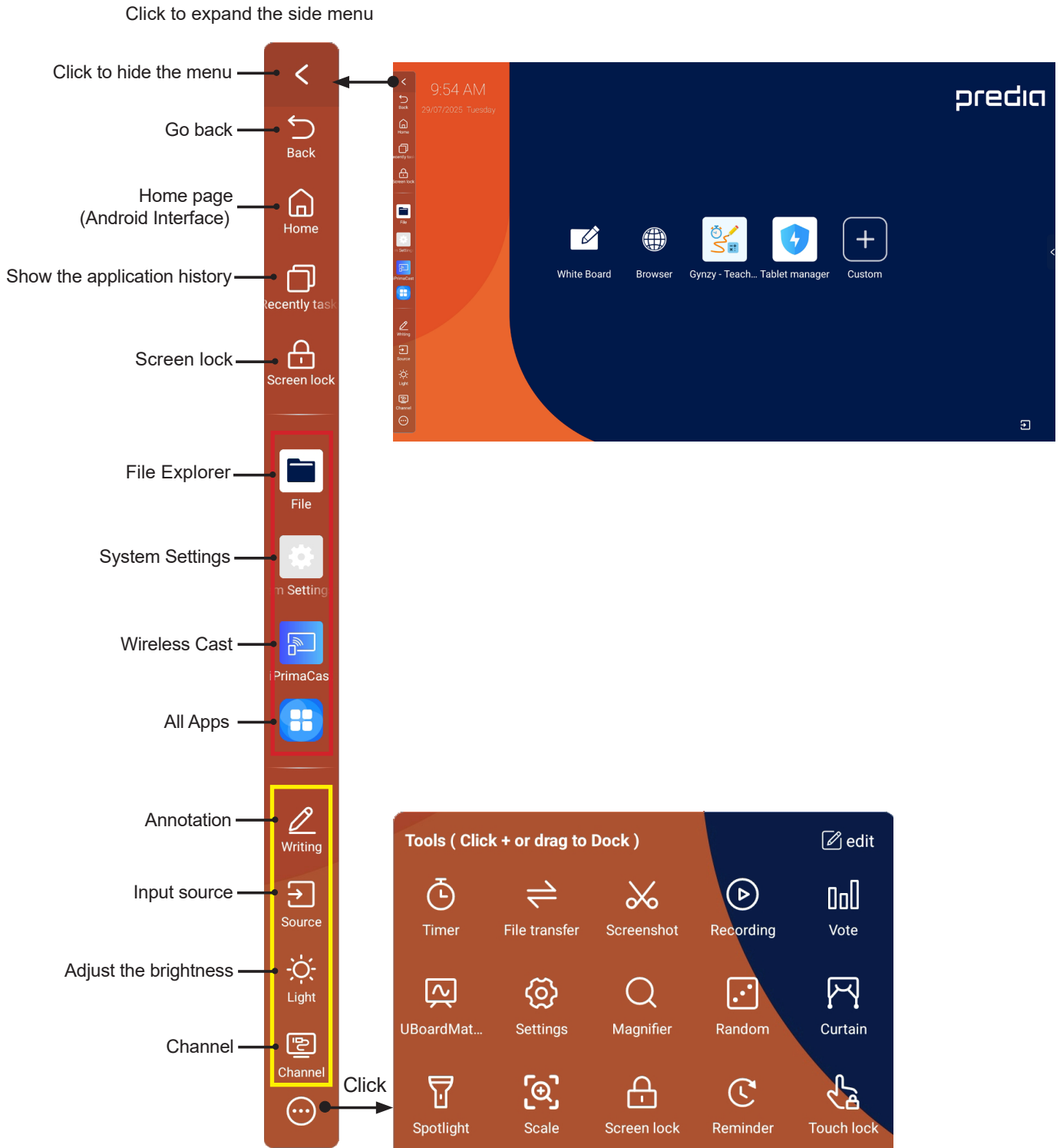

1. Long-press to adjust display position;

2. After clicking the "All Applications" icon, long press and drag the application icon to the red box to replace the original application;

3. After clicking the "Tools" icon, long press and drag the icon in the tool library to the yellow box to replace the original tools;

USER SETTINGS MENU LIST

1. NETWORK & CONNECTED DEVICES

Ethernet: Plug the LAN-cable into the LAN-port on the bottom of the LED, the LED will get an IP address automatically and connect to the internet.

WiFi: Turn the WiFi on. Select the network from WLAN network list to connect it.

Note: Once the LED is connected to the WLAN network successfully then whenever the network is available, the LED will be reconnected to the network without entering the password.

Portable hotspot: Setting Portable WiFi hotspot.

Bluetooth: Automatic search for Bluetooth devices.

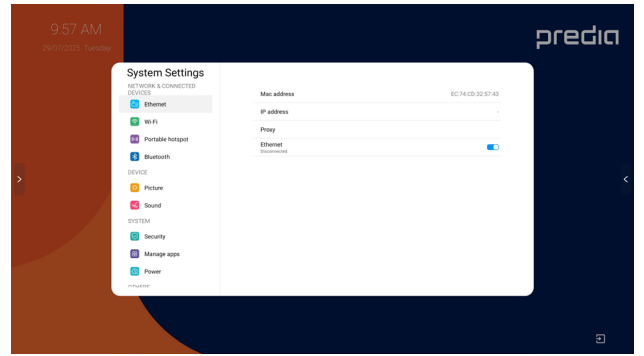

2. DEVICE

2.1 Picture: Adjusting picture.

Picture	Picture mode	Select picture mode. If you select "User", you can set the level of the Contrast, Brightness, Saturation, Sharpness as you desire.
	Energy mode	The backlight brightness is decreased.
	Color temperature	Select the color temperature.
	Eye protect	The backlight brightness is decreased automatically after writing for 3 seconds to protect eyesight. If it had not any writing, the backlight brightness will be returned to before it after about 10 seconds.
	Anti blue light	Turn on to decrease blue light to protect eyesight.
	Backlight	Set up the overall brilliance of the monitor.
Advanced	Contrast	Adjust the contrast.
	Brightness	Adjust the brightness.
	Saturation	Adjust the color saturation.
	Hue	Adjust the hue.
	Color correction	Turn on or off.
	Correction mode	Select the Correction mode.
	Color inversion	Turn on or off.
	High contrast text	Turn on or off.

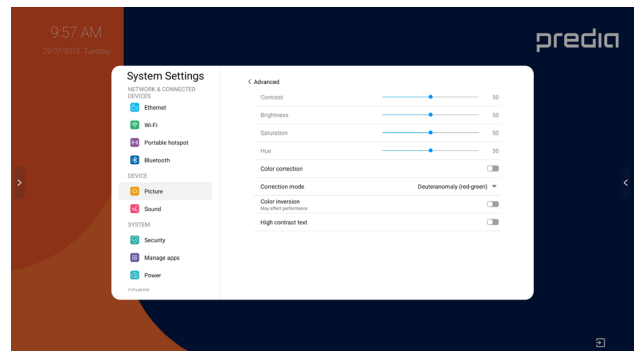
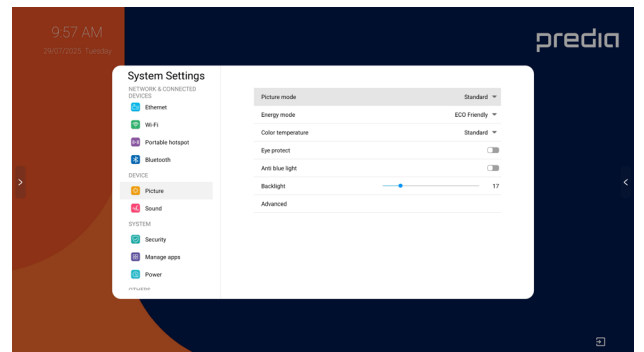

USER MENU LIST

2.2 Sound: Adjusting sound.

Sound	Media out device	Selection of Media out device.
	Sound mode	Select sound mode. If you select "User", you can set the level of the frequency response as you desire.
	SPDIF mode	Select the digital audio output mode. Select "RAW" to output audio signal as its original format. Select "PCM" to output audio signal by PCM format.
	Sound Effect	Turn on or off the surround sound effect.
	Volume	Adjust volume.
	Balance	Adjust volume level of right and left speakers.

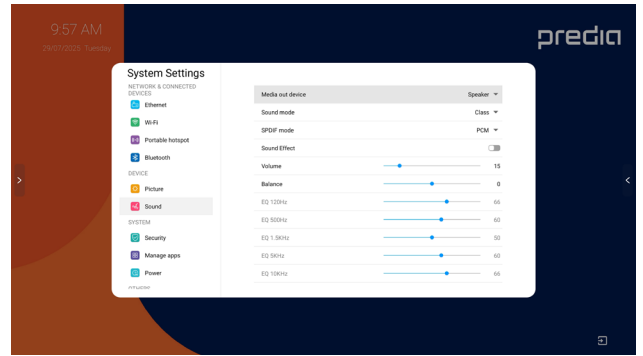

3. SYSTEM

3.1 Security (The default password is 0000)

Change password: Password settings.

App lock: In order to lock the App.

Encryption & credentials

App install/uninstall lock: In order to lock the App install.

Touch lock: To disable the function of the touch panel.

Keypad lock: In order to lock the monitor buttons.

IR lock: To disable the function of the remote. (Except ⏻ button)

Network lock: To disable the function of the network.

Default USB configuration

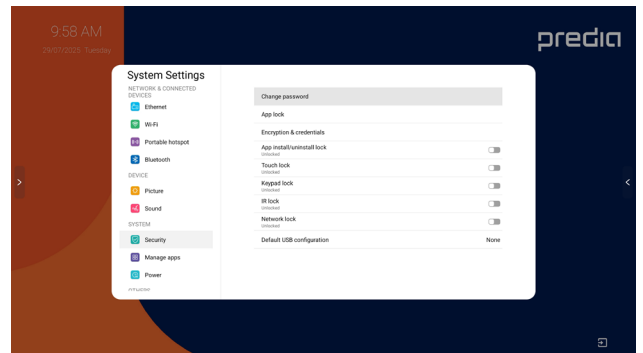

3.2 Manage apps

Installed apps: Displays the list of installed app.

All apps: Display all apps.

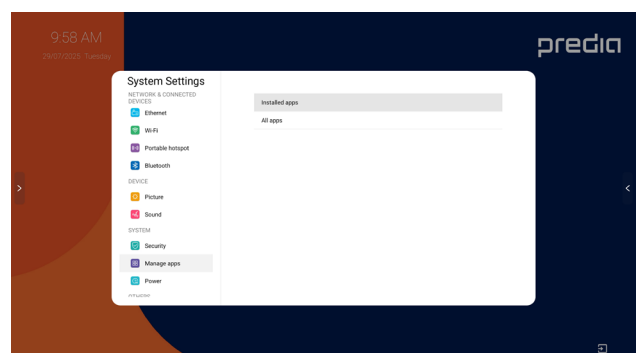

USER MENU LIST

3.3 Power

Timing power on/off

Timing off: To switch the LED to standby at a specified time.

Timing on: To turn on the LED automatically to source at a certain time.

Power on settings:

Power on settings	Power on Source	In Memory mode, when the LED is turned on, it will automatically switch to the source where it powered off last time. Otherwise, it is in setting mode.
	Power on Volume	Select Memory mode, the power on volume will same as the turn off.
	Volume Settings	Select User mode, the power on volume is the value of this setting.
	Boot OPS when Power on	Turn on or off.
	Power on mode	Select Power on mode.

Wake on lan: Turn on or off the wake on lan function.

Sleep timer: Set the duration of time until the LED automatically goes into Standby mode.

Motion detect settings

Auto sleep: Auto Sleep will bring the LED to standby automatically when there is no signal input for a certain time.

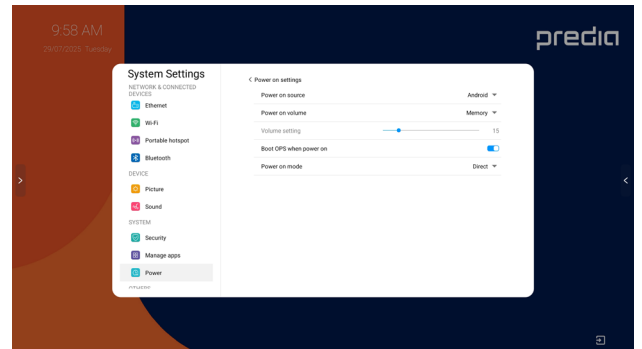
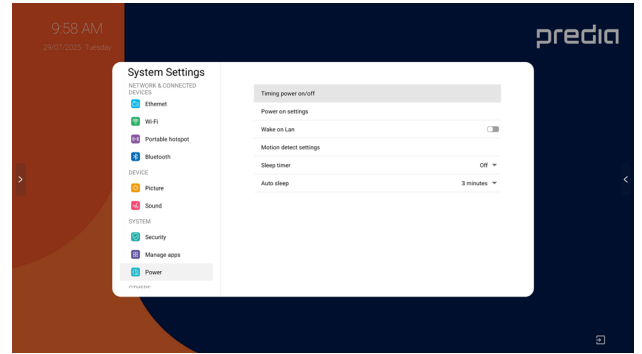

4. OTHERS

4.1 More

Auto source switch: Select On to automatically switch to plug in source (Prompt, Direct).

Temperature protection: Turn on or off the temperature protection function.

Current temperature: Showing the present temperature value of the LED.

Alarm temperature: Setting alarm temperature.

Note: When the temperature protection is turned on, if the current temperature exceeds the alarm temperature, the countdown is on for the LED turn off. If you want to cancel shutdown can be canceled within 30 seconds.

HDMI

HDMI EDID version: Select HDMI EDID Ver.

HDMI CEC: Turn on or off HDMI CEC function.

Date & time: To manually set date and time, you should toggle "Automatic date & time" to OFF.

Languages: Select menu language.

Keyboard & inputs: Setting input method.

Clear browser data: Turn on or off.

Auto clear browser data: Turn on or off.

Individuation: Setting wallpaper, no input wallpaper, source label. Palm Rejection Enable.

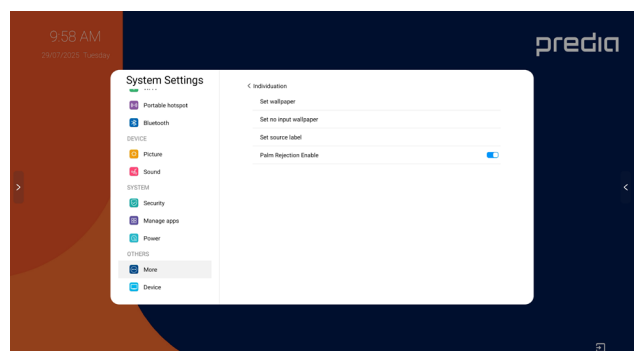
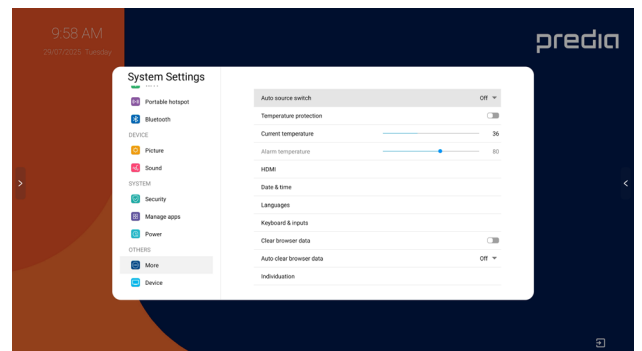

USER MENU LIST

4.2 Device:

It displays the following information:

Device name

Device model

Database Copy: Export to USB, Import from USB.

System information: Display system information.

System updates: Local update, Online update.

Reset: Reset all settings to factory defaults.

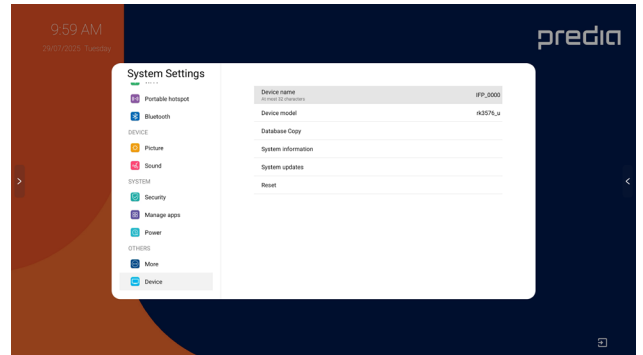

ANNOTATION

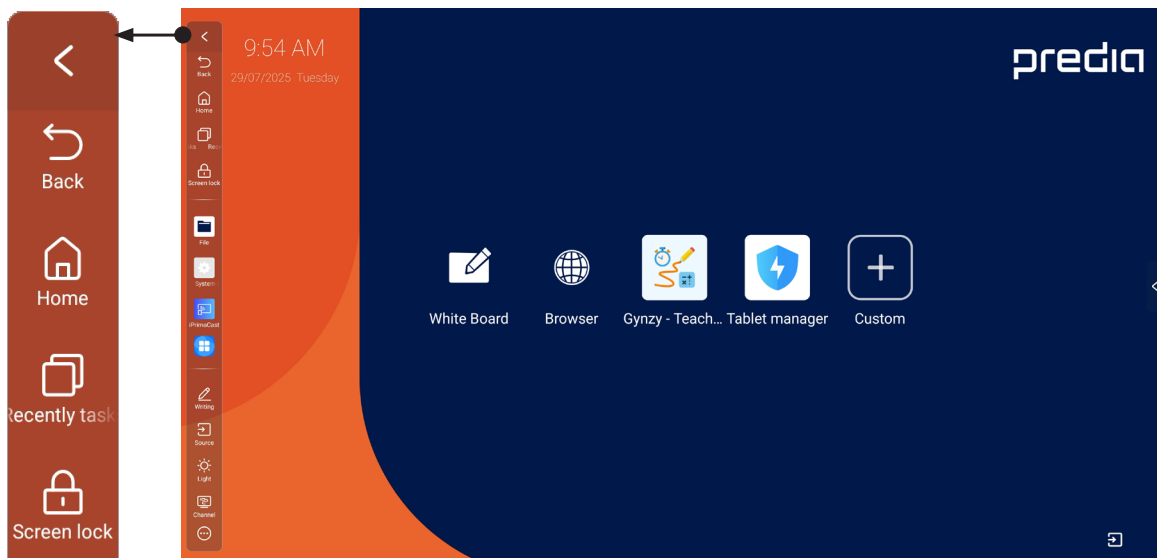

Note: In annotation mode, it supports **Gesture Eraser** function. (When the screen area is sufficiently touched by the hand, the wipe icon appears, move the icon to wipe.)

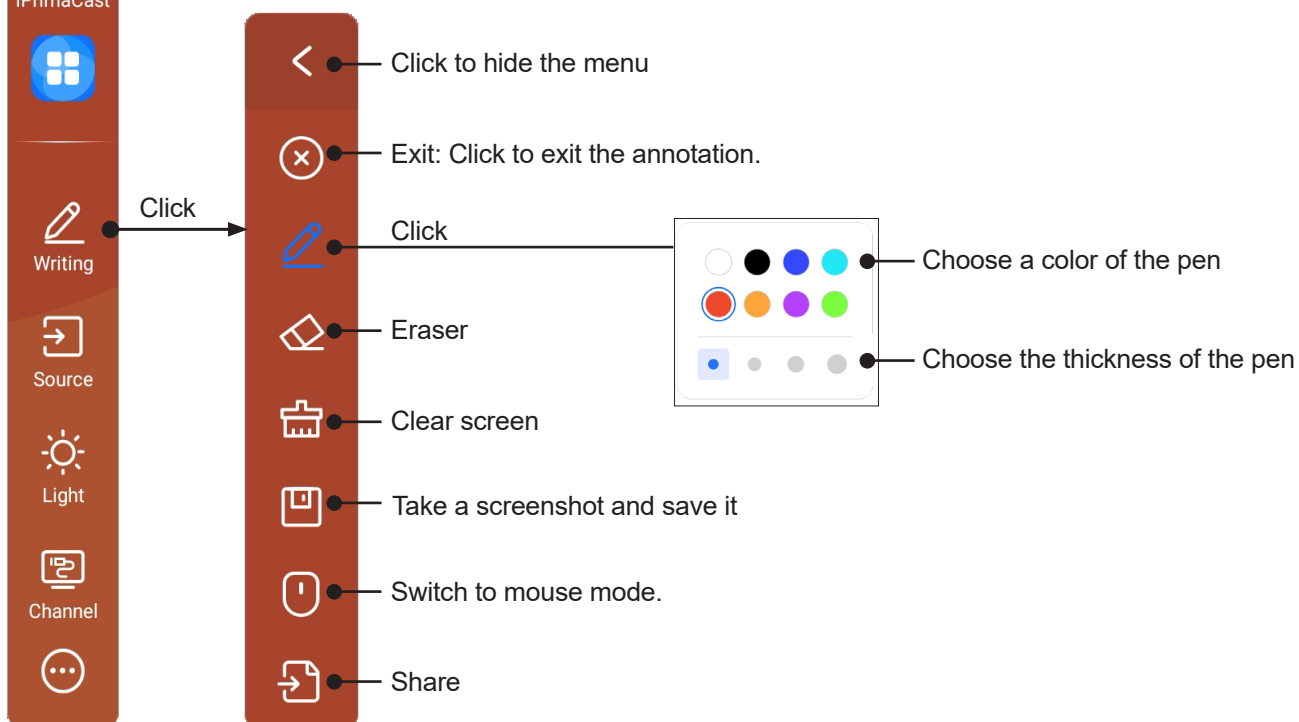

WHITEBOARD

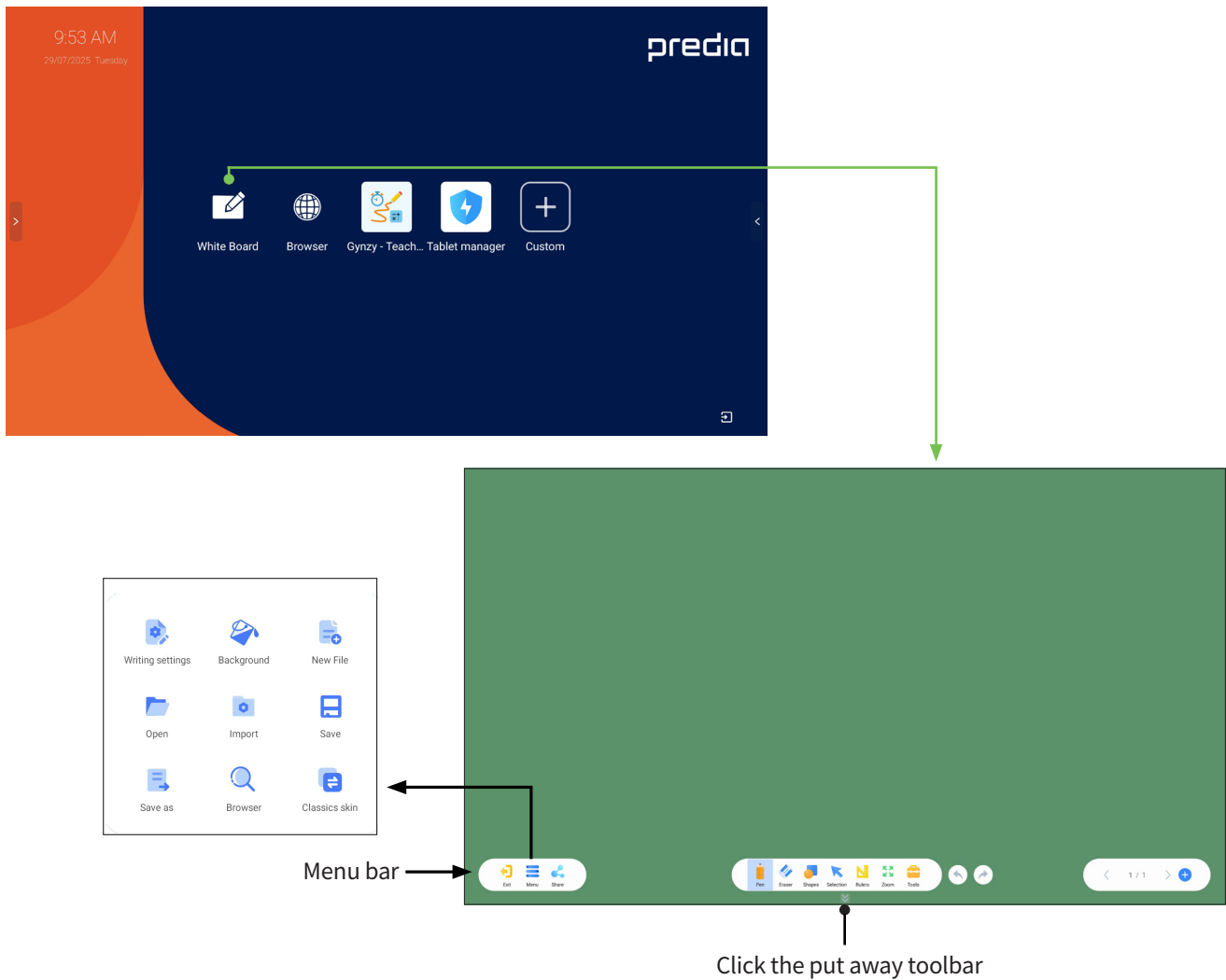

Pen	Select Pen type and set properties of writing
Eraser	Select Eraser type
Shapes	Select commonly used shapes
Selection	Switch to selection mode
Rulers	Choose tools such as Ruler, Triangle ruler etc
Zoom	Switch to roaming mode
Tools	Turn on the tool box
Undo	Cancel operation
Redo	Restore operation
Previous Page	Previous Page
Next page	Next page
add page	Add a new page

File Explorer

Notes:

- Never remove the USB storage device or turn off the LED while using the USB storage device.
- It is recommended that you back-up your USB device data.
- Certain types of USB devices may not be compatible with this LED, please change another.
- Please use only a USB storage device which was formatted as a FAT32 file system.
- You can also use file explorer to view compatible photo, text, movie or play compatible music.

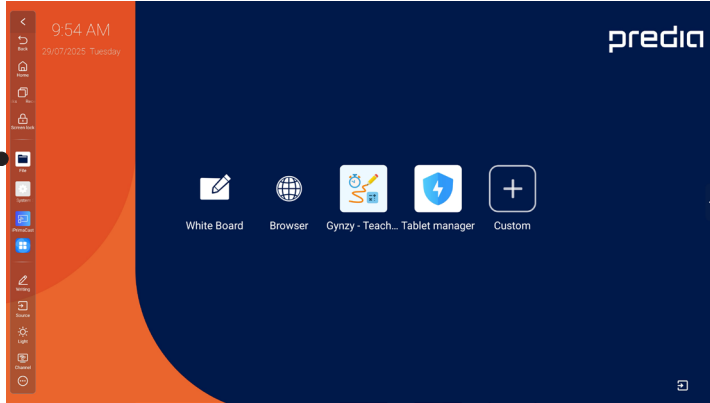

1	File-storage locations		6	Exit	Click to exit file manager
2		Add file or folder		Copy	Click to copy file
		Tile file or folder for window list		Cut	Click to cut file
		List file or folder for window list		Paste	Click to paste file
3	Search file or folder			Rename	Click to rename file
4	Category selection			Delete	Click to delete file
5		Sort			
		MultiSelect/Select All/Unselect			

Wireless Cast

Note:

- Connect device hotspot or in the same network with the device.

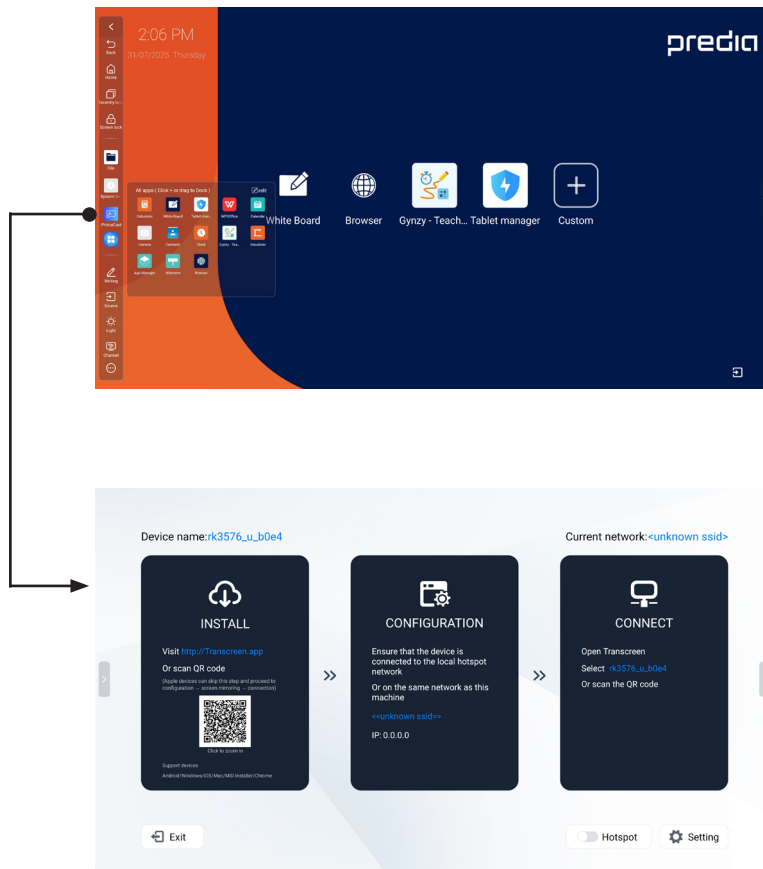

Visualizer

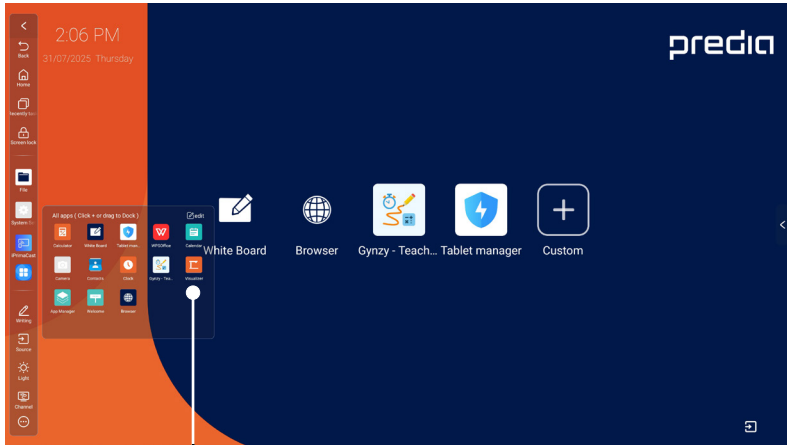

Click to enter Visualizer

Visualizer: Use the high-Speed Scanner or camera to capture items such as books and display them to the client.

Note: Before using the Visualizer function, please connect a high-Speed Scanner or camera to the LED.

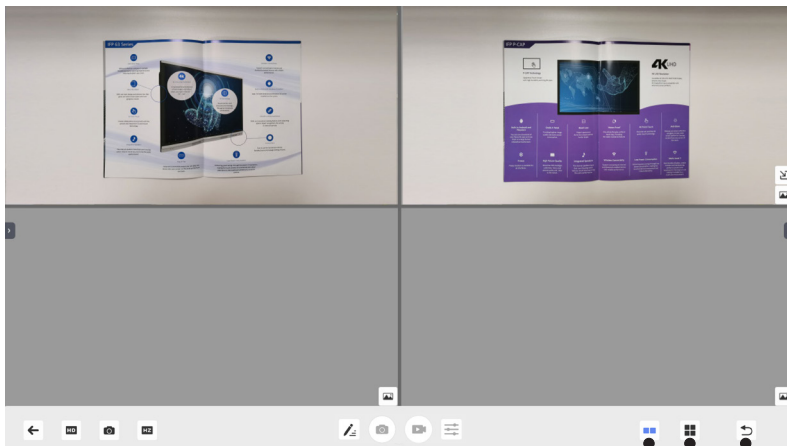
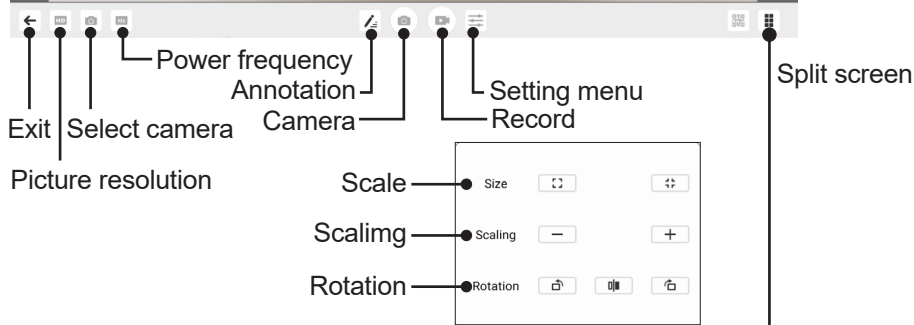

Export the picture to WhiteBoard
Select the picture to insert

Note: You can use gestures to scale, rotate the picture.

Half screen
Quarter screen
Exit split screen mode

TROUBLESHOOTING

If, after reading these operating instructions, you have additional questions related to the use of your LED, please call the services center in your local area.

Before calling service, please check the symptoms and follow suggested solutions.

Remote Control

Problem	Possible Solutions
Remote control does not operate	<ul style="list-style-type: none"> • Make sure the power cord is plugged in. • Check the orientation of the batteries. • The batteries could be weak. Replace the batteries.

Video and Audio

Problem	Possible Solutions
No picture (screen not lit) but no sound	<ul style="list-style-type: none"> • Make sure the power cord is plugged in. • Press POWER on the LED or on the remote control. • Test another source.
Dark, poor or no picture (Screen lit) but good sound	<ul style="list-style-type: none"> • Select a proper picture mode. • Adjust the brightness in the video setting. • Test another source.
No color, dark picture or abnormal color	<ul style="list-style-type: none"> • Adjust the color saturation in the video setting.
Good picture but no sound	<ul style="list-style-type: none"> • The sound may be muted. Press MUTE again to cancel. • Verify if sound should output and/or test another source.
Audio noise	<ul style="list-style-type: none"> • Communication problems may occur if infrared communication equipment (e.g., infrared cordless headphones) is used near the LED. Move the infrared communication equipment away from the LED until the noise is eliminated.

General

Problem	Possible Solutions
Some items can not be accessed	<ul style="list-style-type: none"> • If a setting option appears in gray, this indicates that the settings option is unavailable in current input mode. Some display menu items may be different when the unit works in different sources.
Remote control command is not working in some cases	<ul style="list-style-type: none"> • During the timing of USB device detection (i.e. when the LED is turned on with USB device connected, or when you plug in USB device during the working of the LED), the display may not react on remote control buttons in such case. Wait a moment before the remote control should function again.
Control buttons do not operate	<ul style="list-style-type: none"> • Disconnect the power cord and wait for a few seconds. Then replug the power cord and turn on the unit again.
LED puts itself in stand-by mode as external device or PC goes in sleeping mode	<ul style="list-style-type: none"> • Change the energy settings/sleeping-mode of the external device or PC.
Fog appear on the screen	<ul style="list-style-type: none"> • For the safety of screens, adding stalinite out of the screens. It is need to keep certain space between two layers for reserving air passages generate cross-ventilation and for insuring heat dissipation. Fog mainly comes from the temperature difference between the screen and the external. Moisture streaks congeal when hot air meets the low temperature glass surface The fog does not impact the normal use and it disappears after several-hour usage,

Note: If your problem is not solved, turn off your unit and then on again.

Cautions: Never attempt to repair a defective LED yourself.