

# 1KVA & 2KVA & 3KVA **ONLINE UPS**

---

**PS-POU1K#2B9KR**

**PS-POU2K#4B9KR**

**PS-POU3K#6B9KR**



## **USER MANUAL**

All rights reserved.

The information in this document is subject to change without notice.

## Publish statement

Thank you for purchasing this series UPS.

This series UPS is an intelligent, single phase in single phase out, high frequency online UPS designed by our R&D team who is with years of designing experiences on UPS. With excellent electrical performance, perfect intelligent monitoring and network functions, smart appearance, The UPS meets the world' s advanced level.

Read this manual carefully before installation

This manual provides technical support to the operator of the equipment.

Contact the nearest hazardous waste disposal station when the products or components are discarded

# Table of Contents

<b>1. Important Safety Warning</b> .....	3
<b>1-1 Transportation</b> .....	3
<b>1-2 Preparation</b> .....	3
<b>1-3 Installation</b> .....	3
<b>1-4 Operation</b> .....	4
<b>1-5 Maintenance, service and faults</b> .....	4
<b>1-6 Symbols used in this guide</b> .....	5
<b>2. Installation and setup</b> .....	5
<b>2-1 Unpack checking</b> .....	5
<b>2-2 Real panel view</b> .....	6
<b>2-3 Setup the UPS</b> .....	7
<b>2-4 UPS start up and turn off</b> .....	8
<b>3. Operations</b> .....	12
<b>3-1 Button operation</b> .....	12
<b>3-2 LCD display</b> .....	13
<b>3-3 UPS setting</b> .....	15
<b>3-4 Alarm or Fault reference code</b> .....	18
<b>4. Troubleshooting</b> .....	19
<b>5. Storage and Maintenance</b> .....	21
<b>6. Options</b> .....	21
<b>7. Specification</b> .....	24

# 1. Important Safety Warning

Important safety instructions – Save these instructions

Please comply with all warnings and operating instructions in this manual strictly. Save this manual properly and read carefully the following instructions before installing the unit. Do not operate this unit before reading through all safety information and operating instructions carefully

There exists dangerous voltage and high temperature inside the UPS. During the installation, operation and maintenance, please abide the local safety instructions and relative laws, otherwise it will result in personnel injury or equipment damage. Safety instructions in this manual act as a supplementary for the local safety instructions. Our company will not assume the liability that caused by disobeying safety instructions.

## 1-1 Transportation

- Please transport the UPS system only in the original package to protect against shock and impact.

## 1-2 Preparation

- Condensation may occur if the UPS system is moved directly from cold to warm environment. The UPS system must be absolutely dry before being installed. Please allow at least two hours for the UPS system to acclimate the environment.
- Do not install the UPS system near water or in moist environments.
- Do not install the UPS system where it would be exposed to direct sunlight or near heater.
- Do not block ventilation holes in the UPS housing.

## 1-3 Installation

- Do not connect appliances or devices which would overload the UPS system (e.g. laser printers) to the UPS output sockets.
- Place cables in such a way that no one can step on or trip over them.
- Do not connect domestic appliances such as hair dryers to UPS output sockets.
- The UPS cannot be operated by any individuals with no previous experience.
- Connect the UPS system only to an earthed shockproof outlet which must be easily accessible and close to the UPS system.
- Please use only VDE-tested, CE-marked mains cable (e.g. the mains cable of your computer) to connect the UPS system to the building wiring outlet (shockproof outlet).
- Please use only VDE-tested, CE-marked power cables to connect the loads to the UPS system.

- When installing the equipment, it should ensure that the sum of the leakage current of the UPS and the connected devices does not exceed 3.5mA.
  - Before installing the ups, pay attention to the installation environment and do not install it in places with high temperature, humidity, and dust etc.

## 1-4 Operation

- Do not disconnect the mains cable on the UPS system or the building wiring outlet (shockproof socket outlet) during operations since this would cancel the protective earthing of the UPS system and of all connected loads.
- The UPS system features its own, internal current source (batteries). The UPS output sockets or output terminals block may be electrically live even if the UPS system is not connected to the building wiring outlet.
- In order to fully disconnect the UPS system, first press the OFF/Enter button to disconnect the mains.
- Prevent no fluids or other foreign objects from inside of the UPS system.

## 1-5 Maintenance, service and faults

- The UPS system operates with hazardous voltages. Repairs may be carried out only by qualified maintenance personnel.
- **Caution** - risk of electric shock. Even after the unit is disconnected from the mains (building wiring outlet), components inside the UPS system are still connected to the battery and electrically live and dangerous.
- Before carrying out any kind of service and/or maintenance, disconnect the batteries and verify that no current is present and no hazardous voltage exists in the terminals of high capability capacitor such as BUS-capacitors.
- Only persons are adequately familiar with batteries and with the required precautionary measures may replace batteries and supervise operations. Unauthorized persons must be kept well away from the batteries.
- **Caution** - risk of electric shock. The battery circuit is not isolated from the input voltage. Hazardous voltages may occur between the battery terminals and the ground. Before touching, please verify that no voltage is present!
- Batteries may cause electric shock and have a high short-circuit current. Please take the precautionary measures specified below and any other measures necessary when working with batteries:
  - remove wristwatches, rings and other metal objects
  - use only tools with insulated grips and handles.
- When changing batteries, install the same number and same type of batteries.
- Do not attempt to dispose of batteries by burning them. This could cause battery explosion.

- Do not open or destroy batteries. Escaping electrolyte can cause injury to the skin and eyes. It may be toxic.
- Please replace the fuse only with the same type and amperage in order to avoid fire hazards.
- Do not dismantle the UPS system.

## 1-6 Symbols used in this guide



### **WARNING!**

Risk of electric shock



### **CAUTION!**

Read this information to avoid equipment damage

## 2. Installation and setup

**NOTE:** Before installation, please inspect the unit. Be sure that nothing inside the package is damaged. Please keep the original package in a safe place for future use.

### 2-1 Unpack checking

- Don't lean the UPS when moving it out from the packaging.
- Check the appearance to see if the UPS is damaged or not during the transportation, do not switch on the UPS if any damage found. Please contact the dealer right away.
- Check the accessories according to the packing list and contact the dealer in case of missing parts.

It includes:

- (1) UPS user's guide
- (2) USB cable
- (3) Power cord (Input or output)
- (4) RS232 cable

## 2-2 Real panel view

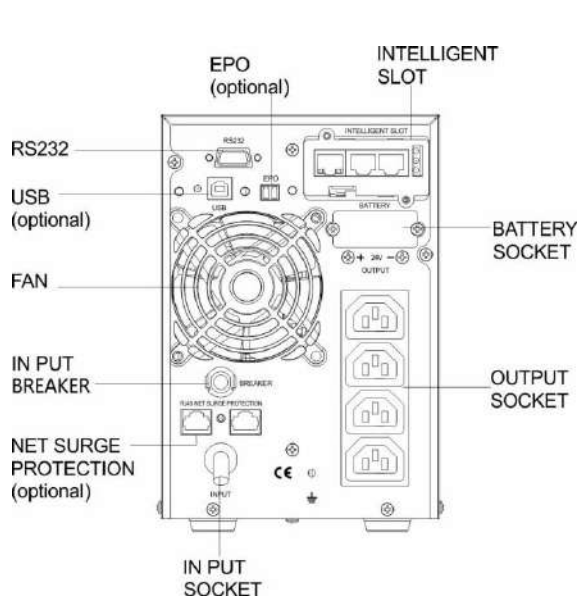

Fig.1 1KVA/ Rear Panel View

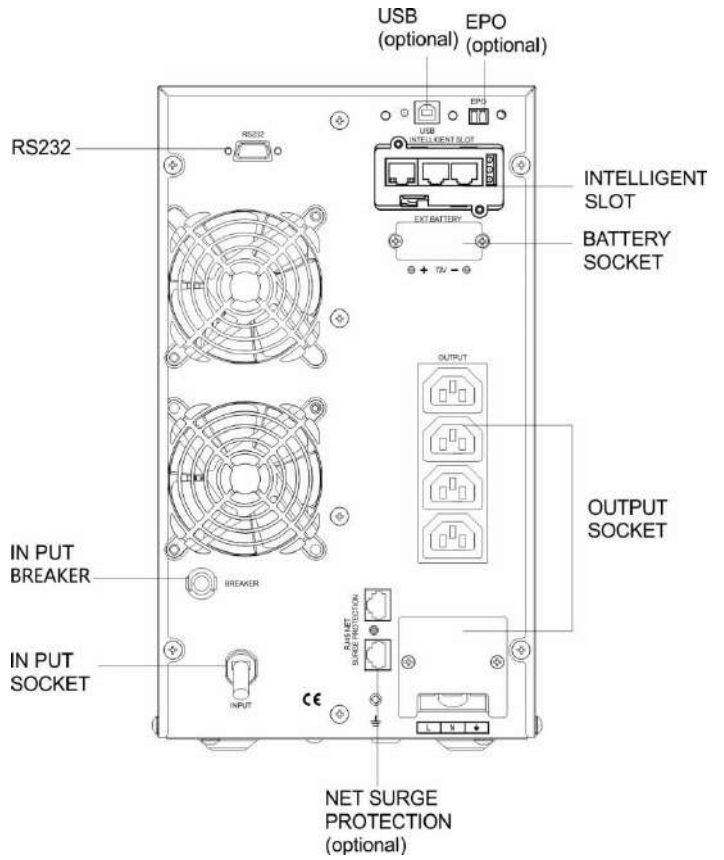

Fig.2 2KVA/3KVA Rear Panel View

Output socket type	
	USA STANDARD SOCKET
	IEC SOCKET
	CHINESE STANDARD SOCKET
	INDIAN STANDARD SOCKET
	UNIVERSAL SOCKET
	SOUTH AFRICA SOCKET
	GERMANY STANDARD SOCKET
	AUSTRALIAN STANDARD SOCKET

## 2-3 Setup the UPS

### Step 1: UPS input connection

Plug the UPS into a two-pole, three-wire, grounded receptacle only. Avoid using extension cords.

- For 200/208/220/230/240VAC models: The power cord is supplied in the UPS package.

### Step 2: UPS output connection

- For socket-type outputs, simply connect devices to the outlets.
- For terminal-type input or outputs, please follow below steps for the wiring configuration:
  - a) Remove the small cover of the terminal block
  - b) Suggest using AWG14 or 2.1mm<sup>2</sup> power cords for 3KVA (200/208/220/230/240VAC models).
  - c) Upon completion of the wiring configuration, please check whether the wires are securely affixed.
  - d) Put the small cover back to the rear panel.

### Step 3 Communication connection

Communication port:

**USB port**



**RS-232 port**

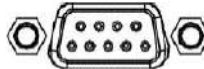

**Intelligent slot**



To allow for unattended UPS shutdown/start-up and status monitoring, connect the communication cable one end to the USB/RS-232 port and the other to the communication port of your PC. With the monitoring software installed, you can schedule UPS shutdown/start-up and monitor UPS status through PC.

The UPS is equipped with intelligent slot perfect for either SNMP or Relay card. When installing either SNMP or Relay card in the UPS, it will provide advanced communication and monitoring options.

**NOTE: USB port and RS-232 port can't work at the same time.**

### Step 4: Turn on the UPS

Press the ON button on the front panel for two seconds to power on the UPS.

**Note:** The battery charges fully during the first five hours of normal operation. Do not expect full battery run capability during this initial charge period.

### Step 5: Install software

Find the download link on the software installation guide in the packaging box, download the corresponding software package then install.

### Step 6: External battery connection

If your UPS is not including batteries. Please connect external batteries as below chart.

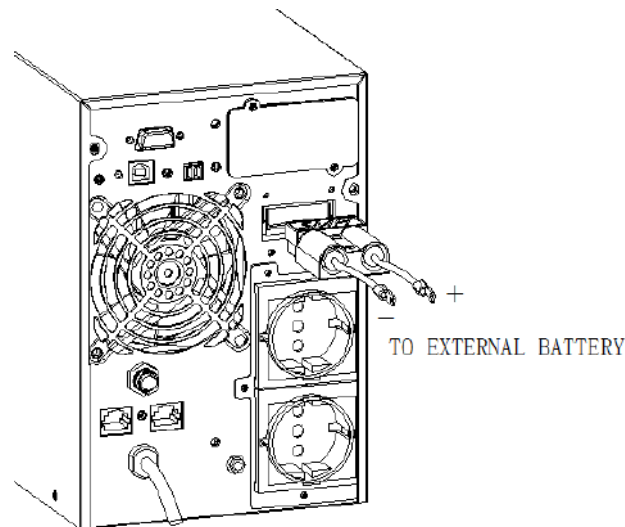

## 2-4 UPS startup and turn off

### ● Startup operation

(1) Turn on the UPS in line mode

**NOTE** Verify that the total equipment ratings do not exceed the UPS capacity to prevent an overload alarm.

- a) Once mains power is plugged in, the UPS go to standby mode with bypass no output, all indicator lights are in the off state, turn on battery charging, if it is expected to change to Inverter output model, you can Press "ON" key.
- b) Press and hold the ON key for more than three seconds to start the UPS, then it will start the inverter.
- c) Once started, the UPS will perform a self-test function, LED will light and go out circularly and orderly. When the self-test finishes, it will come to line mode, the corresponding LED lights, the UPS is working in line mode.

(2) Turn on the UPS by DC without mains power

- a) When mains power is disconnected, press and hold the ON key for more than half a second to start UPS.
- b) The operation of the UPS in the process of start is almost the same as that when mains power is in. After finishing the self-test, the corresponding LED lights and the UPS is working in battery mode.

### ● Turn off operation

(1) Turn off the UPS in line mode

- a) Press and hold the OFF key for more than half a second to turn off the UPS and inverter.
- b) After the UPS shutdown, the LEDs go out and there is no output. If output is needed, you can set bps "ON" on the LCD setting menu.

(1) Turn off the UPS by DC without mains power

- a) Press and hold the OFF key for more than half a second to turn off the UPS.
- b) When turning off the UPS, it will do self-testing firstly. The LEDs light and go out circularly and orderly until there is no display on the cover.

● **Operation and Display Panel**



The operation and display panel, shown in below chart, is on the front panel of the inverter. It includes four indicators, four function keys and an LCD display, indicating the operating status and input/output power information.

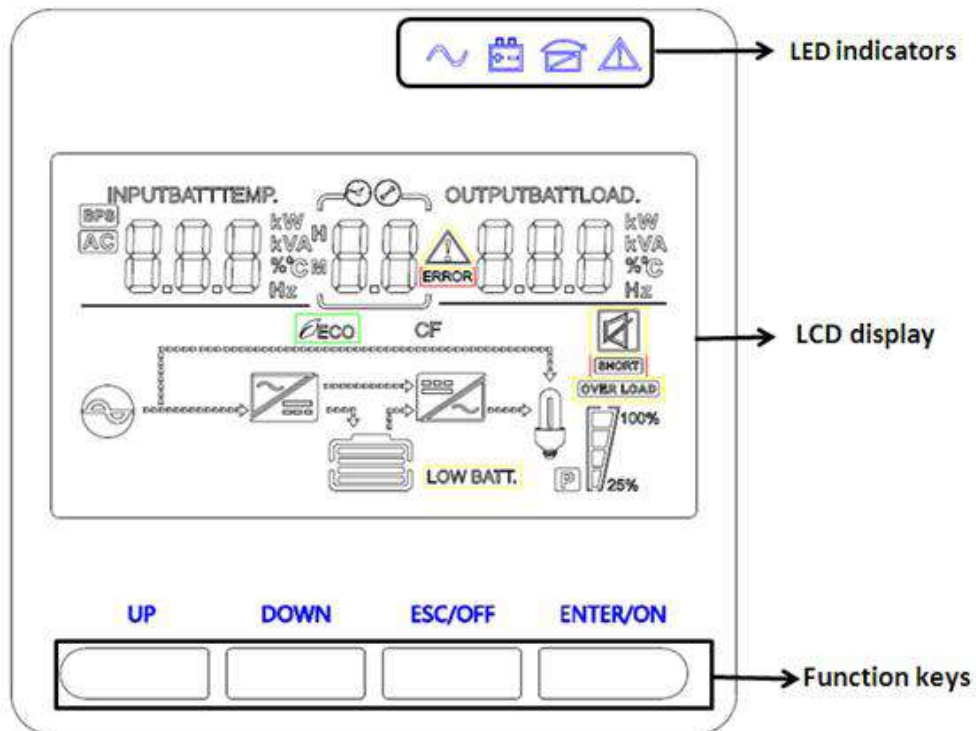

LCD control panel introduction



- (1) LED (from right to left: "alarm" , "bypass" , "battery" , "inverter" );
- (2) On-Line UPS LCD display; (3) Function keys

LED Indicator

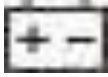
Indicator	Description
 Red	On, the UPS has an active alarm or fault.
 Yellow	The UPS is in Bypass mode. On, the UPS is operating normally on bypass during High Efficiency operation.

 Yellow	On, the UPS is in Battery mode.
 Green	On, the UPS is operating normally.

**NOTE** When power on or startup, these indicators will turn on and off sequentially.









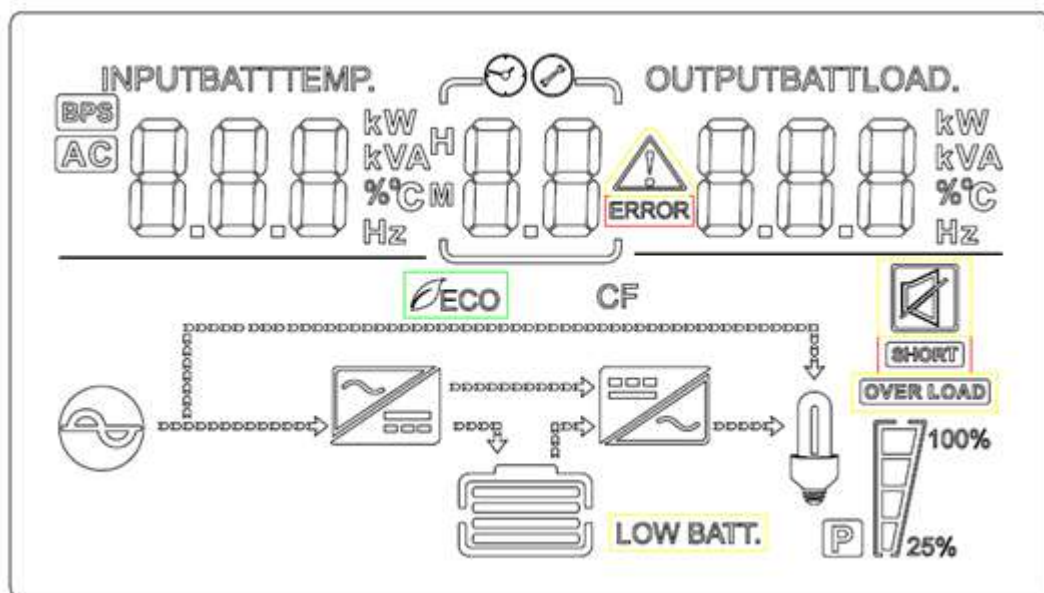

**NOTE** On different operation modes, these indicators will indicate differently.





### Function Keys

Function Key	Description
ESC/OFF	To turn off the ups or exit setting mode without save.
UP	To go to previous selection
Down	To go to next selection
ENTER/ON	To turn on the ups or confirm the selection in setting mode or enter setting mode

### LCD Display Icons

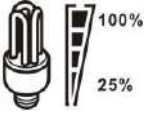

Icon	Function description												
<b>Input Source Information</b>													
	Indicates the AC input.												
	Indicates input voltage, input frequency, battery voltage and Temperature.												
<b>Configuration Program and Fault Information</b>													
	Indicates the setting programs.												
	Indicates the warning and fault codes. Warning:  flashing with warning code.												
	Fault:  lighting with fault code												
<b>Output Information</b>													
	Indicate output voltage, output frequency, load percent, load in VA, load in Watt												
<b>Battery Information</b>													
	Indicates battery level by 0-24%, 25-49%, 50-74% and 75-100% in battery mode and charging status in line mode.												
In AC mode, it will present battery charging status.													
<table border="1"> <thead> <tr> <th>Status</th> <th>Battery capacity</th> <th>LCD Display</th> </tr> </thead> <tbody> <tr> <td rowspan="4">Floating mode</td> <td>0-24%</td> <td>4 bars will flash in turns</td> </tr> <tr> <td>25-49%</td> <td>Bottom bar will be on and the other three bars will flash in turns</td> </tr> <tr> <td>50-74%</td> <td>Bottom two bars will be on and the other two bars will flash in turns</td> </tr> <tr> <td>75-100%</td> <td>Bottom three bars will be on and the top bars will flash</td> </tr> </tbody> </table>	Status	Battery capacity	LCD Display	Floating mode	0-24%	4 bars will flash in turns	25-49%	Bottom bar will be on and the other three bars will flash in turns	50-74%	Bottom two bars will be on and the other two bars will flash in turns	75-100%	Bottom three bars will be on and the top bars will flash	
Status	Battery capacity	LCD Display											
Floating mode	0-24%	4 bars will flash in turns											
	25-49%	Bottom bar will be on and the other three bars will flash in turns											
	50-74%	Bottom two bars will be on and the other two bars will flash in turns											
	75-100%	Bottom three bars will be on and the top bars will flash											
<b>Load Information</b>													
	Indicates overload.												
	Indicates the load level by 0-24%, 25-49%, 50-74% and 75-100%.												

	0%~24%	25%~49%	50%~74%	75%~100%
<b>Mode Operation Information</b>				
	Indicates unit connects to the mains.			
<b>BYPASS</b>	Indicates load is supplied by utility power.			
	Indicates the utility charger circuit is working.			
	Indicates the DC/AC inverter circuit is working.			
<b>Mute Operation</b>				
	Indicates unit alarm is disabled.			

### 3. Operations

#### 3-1 Button operation

Button	Function
<b>ON /ENTER Button</b>	<ul style="list-style-type: none"> <li>➤ <b>Turn on the UPS:</b> Press and hold ON button for at least 2 seconds to turn on the UPS.</li> <li>➤ <b>Confirm current settings:</b> When the UPS enters the setting mode, must press this button to confirm the settings value what you want, next press up/down button to change settings information</li> <li>➤ <b>Out of bypass mode:</b> when the UPS enter to bypass mode, press and hold this button it will switch to normal mode.</li> <li>➤ <b>Switch to UPS self-test mode:</b> Press and hold this button for 2 seconds to enter UPS self-testing while in AC mode</li> </ul>
<b>OFF/ESC Button</b>	<ul style="list-style-type: none"> <li>➤ <b>Turn off the UPS:</b> Press and hold this button at least 2 seconds to turn off the UPS in battery mode. UPS will be in standby mode under power normal or transfer to bypass</li> </ul>

	<p>mode if the Bypass enable setting by pressing this button.</p> <ul style="list-style-type: none"> <li>➤ <b>Exit setting mode:</b> Press this button to exit setting mode when in UPS setting mode, but save nothing.</li> </ul>
<b>UP Button</b>	<ul style="list-style-type: none"> <li>➤ <b>Up key:</b> Press this button to display previous selection in UPS setting mode.</li> </ul>
<b>DOWN Button</b>	<ul style="list-style-type: none"> <li>➤ <b>Down key:</b> Press this button to display next selection in UPS setting mode.</li> <li>➤ <b>To confirm selection and exit setting mode:</b> Press this button to confirm selection and exit setting mode when LCD display the last selection in UPS setting mode.</li> </ul>
<b>UP + DOWN Button</b>	<ul style="list-style-type: none"> <li>➤ <b>Setting mode:</b> Press and hold this button for 5 seconds to enter UPS setting mode.</li> </ul>

## 3-2 LCD display

### Part one: Rack display

There are 8 interfaces available in the LCD display.

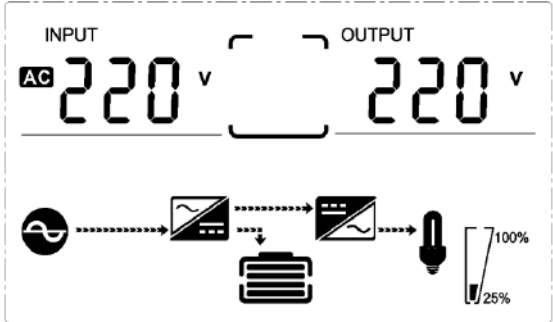
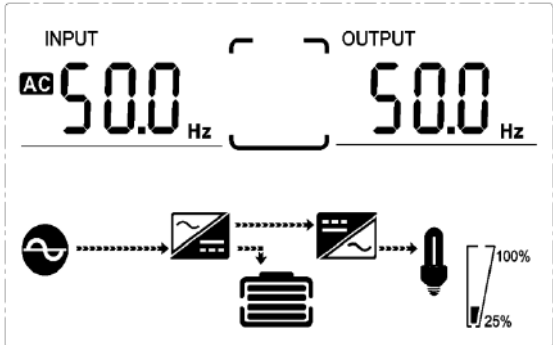
Item	Interface Description	Content Displayed
01	Input voltage& Output voltage	
02	Input frequency& Output frequency	

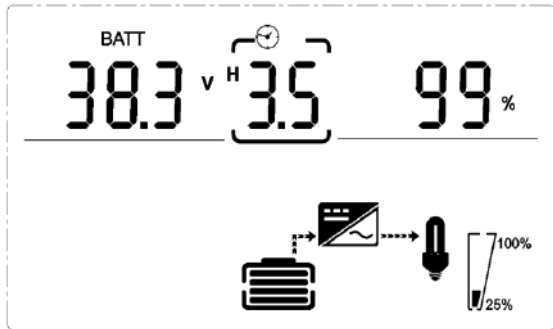
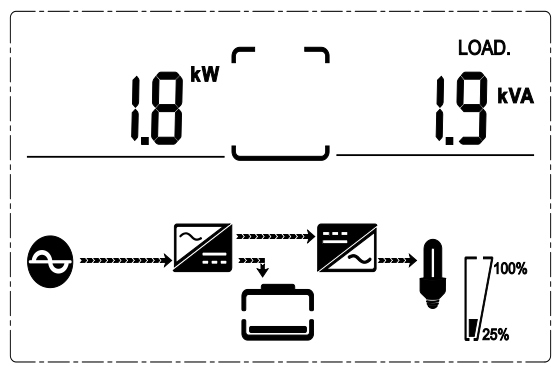
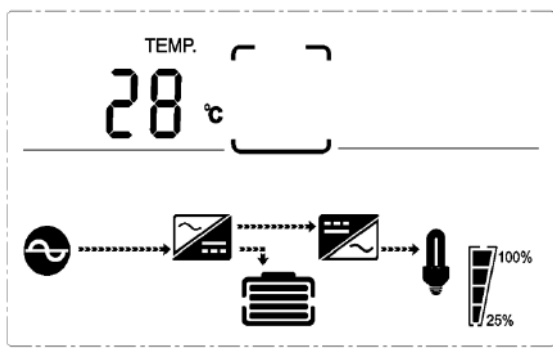
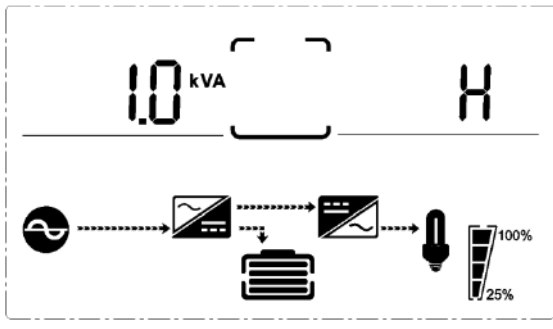
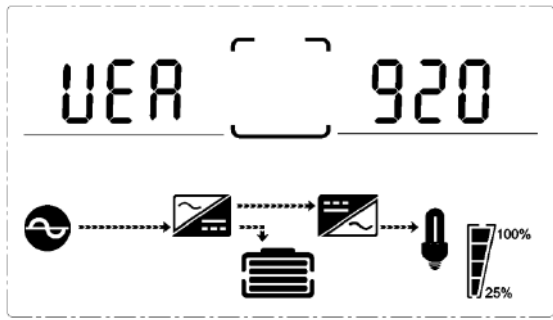
<p>03</p>	<p>Battery voltage &amp; Battery capacity</p>	
<p>04</p>	<p>Load</p>	
<p>05</p>	<p>Environment Temperature</p>	
<p>06</p>	<p>UPS model</p>	
<p>07</p>	<p>Firmware Version</p>	

08	<p>Alarm Code(Warming Message)</p> <p>All alarm codes are present when abnormal behavior(s) occur(s)</p>	
----	--	--

### 3-3 UPS setting

The UPS has setting functions. This user settings can be done under any kind of UPS working mode. The setting will take effect under certain condition. Below table describes how to set the UPS.

The setting function is controlled by 4 buttons (Up, Down, ON/Enter, OFF/ESC):

Up ▲ + OFF/Down ▼ --- goes into the setting page,





ON/Enter ---- confirm the settings options



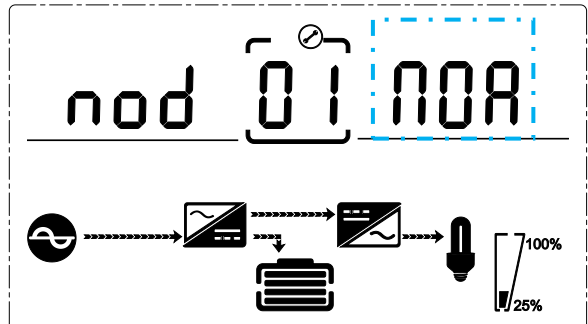

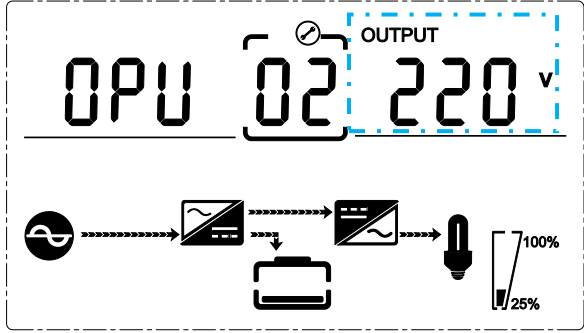
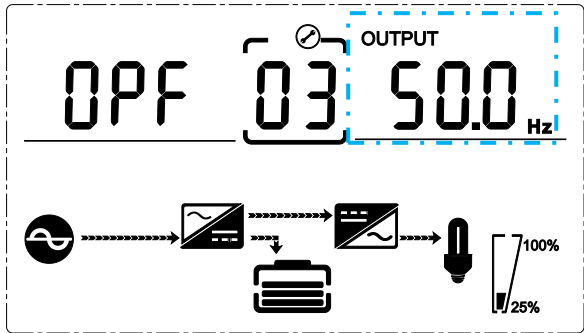
Up ▲ & Down ▼ --- value adjustment Or for choosing different pages.

After the UPS turn ON, press buttons "▲&▼" for 5 seconds and then goes into the setting interface page.

**Note: Press "Down" button to confirm selection and exit setting mode when LCD display the last selection in UPS setting mode.**

Item	Settings	Content display
01	<p>Mode setting</p> <p>Press Enter button to change the setting (ECO or NOR or CF or GEN).</p> <p>Press UP button ▲ to select the previous setting.</p> <p>Press DOWN button ▼ to select the next setting.</p>	

<p>02</p>	<p><b>Output voltage setting</b></p> <p>Press Enter button to change the setting(200, 208, 220, 230, 240). Press UP button ▲ to select the previous setting. Press DOWN button ▼ to select the next setting.</p>	
<p>03</p>	<p><b>Frequency setting</b></p> <p>Press Enter button to change the setting (50 or 60Hz). Press UP button ▲ to select the previous setting. Press DOWN button ▼ to select the next setting.</p>	
<p>04</p>	<p><b>Battery capacity setting</b></p> <p>Press Enter button to change the setting (Battery capacity range is 1-200Ah). Press UP button ▲ to select the previous setting. Press DOWN button ▼ to select the next setting.</p>	
<p>05</p>	<p><b>Battery EOD voltage setting (Segment 1)</b></p> <p>Press Enter button to change the setting (1.75/1.84/1.92). Press UP button ▲ to select the previous setting. Press DOWN button ▼ to select the next setting.</p>	
<p>06</p>	<p><b>Battery EOD voltage setting (Segment 2)</b></p> <p>Press Enter button to change the setting (1.60/1.70/1.75/1.80). Press UP button ▲ to select the previous setting. Press DOWN button ▼ to select the next setting.</p>	

<p>07</p>	<p>Bypass voltage upper limit setting</p> <p>Press Enter button to change the setting (The bypass voltage upper limit range is 230-264Vac).</p> <p>Press UP button ▲ to select the previous setting.</p> <p>Press DOWN button ▼ to select the next setting.</p>	
<p>08</p>	<p>Bypass voltage lower limit setting</p> <p>Press Enter button to change the setting (The bypass voltage lower limit range is 176-220Vac).</p> <p>Press UP button ▲ to select the previous setting.</p> <p>Press DOWN button ▼ to select the next setting.</p>	
<p>09</p>	<p>Mute setting</p> <p>Press Enter button to change the setting (ON or OFF).</p> <p>Press UP button ▲ to select the previous setting.</p> <p>Press DOWN button ▼ to save and exit the setup.</p>	
<p>10</p>	<p>BYPASS enable/disable setting</p> <p>Press Enter button to change the setting (ON or OFF).</p> <p>Press UP button ▲ to select the previous setting.</p> <p>Press DOWN button ▼ to save and exit the setup.</p>	

### 3-4 Alarm or Fault reference code

Event log	UPS Alarm Warning	Buzzer	LED
1	Rectifier Fault	Beep continuously	Fault LED lit
2	Inverter fault (Including Inverter bridge is shorted)	Beep continuously	Fault LED lit
9	Fan fault	Beep continuously	Fault LED lit
12	Self-test fault	Beep continuously	Fault LED lit
13	Battery Charger fault	Beep continuously	Fault LED lit
15	DC Bus over voltage	Beep continuously	Fault LED lit
16	DC Bus below voltage	Beep continuously	Fault LED lit
17	DC bus unbalance	Beep continuously	Fault LED lit
18	Soft start failed	Beep continuously	Fault LED lit
19	Environment temperature Over Temperature	Twice per second	Fault LED blinking
20	Inverter model Over Temperature	Twice per second	Fault LED blinking
26	Battery over voltage	Twice per second	Fault LED blinking
27	Mains Input reverse	Once per second	Fault LED blinking
28	Bypass Input reverse	Once per second	Fault LED blinking
29	Output Short-circuit	Beep continuously	Fault LED lit
30	Input current limit	Once per second	Fault LED blinking
31	Bypass over current	Once per second	BPS LED blinking
32	Overload	Once per second	INV or BPS LED blinking
33	No battery	Once per second	Battery LED blinking
34	Battery under voltage	Once per second	Battery LED blinking
35	Battery low pre-warning	Once per 2 seconds	Battery LED blinking
36	Over load time out	Once per 2 seconds	Fault LED blinking
37	DC component over limit.	Once per 2 seconds	INV LED blinking
39	Mains volt. Abnormal	Once per 2 seconds	BPS LED blinking
40	Mains freq. abnormal	Once per 2 seconds	BPS LED blinking
41	Bypass Not Available	None	BPS LED blinking
42	Bypass out of tracking range	None	BPS LED blinking
45	EPO Enable	Beep continuously	Fault LED lit

## 4. Troubleshooting

If the UPS system does not operate correctly, please solve the problem by using the table below and the Trouble Shooting Chart.

Symptom	Possible cause	Remedy
No indication and alarm even though the mains is normal.	The AC input power is not connected well.	Check if input power cord firmly connected to the mains.
	The AC input is connected to the UPS output.	Plug AC input power cord to AC input correctly.
Alarm code is shown as “33” and battery led blinking.	The external or internal battery is incorrectly connected.	Check if all batteries are connected well.
Alarm code is shown as “26” and battery led blinking.	Battery voltage is too high or the charger is fault.	Contact your dealer.
Alarm code is shown as “34” and battery led blinking	Battery voltage is too low or the charger is fault.	Contact your dealer.
Alarm code is shown as “32” and INV or BYPASS led blinking.	UPS is overload	Remove excess loads from UPS output.
Alarm code is shown as “27&28” and FAULT led light.	Mains Input reverse& Bypass Input reverse	Check input L/N wiring Reverse connection
Alarm code is shown as “29” and FAULT led light.	The UPS shut down automatically because short circuit occurs on the UPS output.	Check output wiring and if connected devices are in short circuit status.
Alarm code is shown as “9” and FAULT led light.	Fan fault.	Contact your dealer.
Alarm code is shown as “01,02, 15,16,17,18”	A UPS internal fault has occurred.	Contact your dealer.
Battery backup time is shorter than nominal value	Batteries are not fully charged	Charge the batteries for at least 5 hours and then check capacity. If the problem still persists, consult your dealer.
	Batteries defect	Contact your dealer to replace the battery.

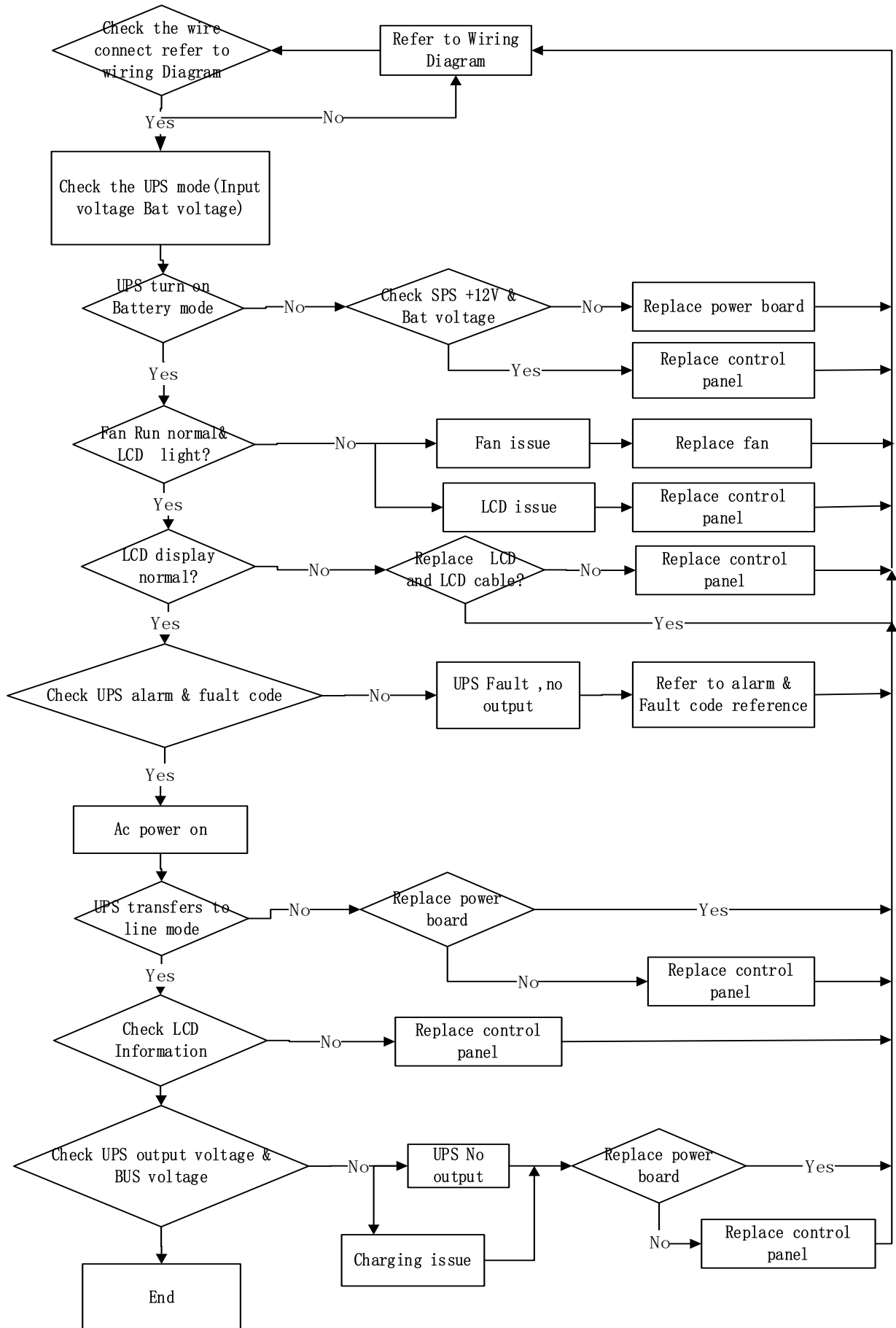

Trouble Shooting Chart

## 5. Storage and Maintenance

### ● Operation

The UPS system contains no user-serviceable parts. If the battery service life (3~5 years at 25°C ambient temperature) has been exceeded, the batteries must be replaced. In this case, please contact your dealer.



Ph



Ph

Be sure to deliver the spent battery to a recycling facility or ship it to your dealer in the replacement battery packing material.

### ● Storage

Before storing, charge the UPS 5 hours. Store the UPS covered and upright in a cool, dry location. During storage, recharge the battery in accordance with the following table:

Storage Temperature	Recharge Frequency	Charging Duration
-25°C - 40°C	Every 3 months	1-2 hours
40°C - 45°C	Every 2 months	1-2 hours

## 6. Options

**SNMP card:** internal SNMP (Options)

- ◆Loosen the 2 torque screws (on each side of the card).
- ◆Carefully insert the SNMP card and lock the screws

KPM220 is a built-in network SNMP card independently, it supports SNMPv1/v2 and v3 protocols, features e-mail alarm, historical events and historical data storage. Picture is shown as below,



Download installation files from <http://download.ksdatacloud.com>,

Specific operation and function description are provided for reference: [KPM220 User Manual V2.2](#)

### Relay card (Options)

Mini dry contact card is used for providing the interface for UPS peripheral monitoring. The contact signals can reflect UPS running status. The card is connected to peripheral monitoring devices via terminal board to facilitate the effective monitoring of the real-time status of UPS and timely feedback the status to monitor when abnormal situation occurs (such as UPS failure, mains interruption, UPS bypass and act.). It is installed in the intelligent slot of the UPS. The relay card includes 6 output ports and one input port. Please refer to the following table for detail.



Pins definition of connecting terminal on the board

Terminal No.	Terminal function	Terminal No.	Terminal function
1	Common source	9	Bypass enable NO
2	UPS on NC	10	Bypass enable NC
3	AC fail NO	11	UPS fail NO
4	AC fail NC	12	UPS fail NC
5	Batt low NO	CN4-1	Remote shutdown
6	Batt low NC	CN4-2	GND
7	UPS alarm NO		
8	UPS alarm NC		

**Relay card electrical parameter**

	max	Type
Relay card contact	(Max Switched Voltage) AC:120V DC:24V	AC:120V
		DC:5~12V
	(Max Switched Current) AC:1A DC:1A	AC:1A
		DC:1A

**Emergency Power-off (EPO) (Options)**

EPO is used to shut down the UPS from a distance. This feature can be used for shutting down the load and the UPS by thermal relay, for instance in the event of room over temperature. When EPO is activated, the UPS shuts down the output and all its power converters immediately. The UPS remains on to alarm the fault.



EPO Connections

**NOTE** Depending on user configuration, the pins must be shorted or opened to keep the UPS running. To restart the UPS, reconnect (re-open) the EPO connector pins and turn on the UPS manually. Maximum resistance in the shorted loop is 10 ohms. Always test the EPO function before applying your critical load to avoid accidental load loss. Leave the EPO connector installed onto the EPO port of the UPS even if the EPO function is not needed.

**Load Segments (Options)**

Load segments are sets of receptacles that can be controlled by power management software or through the display, providing an orderly shutdown and startup of your equipment. For example, during a power outage, you can keep critical equipment running while you turn off other equipment. This feature allows you to save battery power. Each UPS has two load segments:

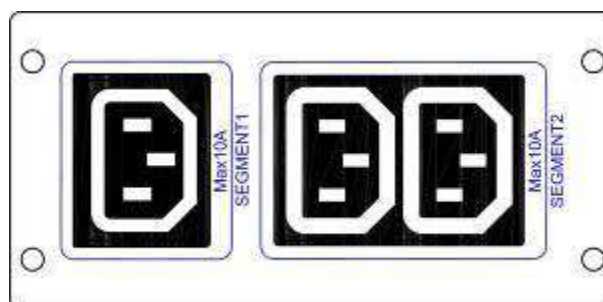

Segment 1: The power shedding battery voltage of this segment can be set by LCD. (Refer to Battery EOD voltage setting (Segment 1))

Segment 2: The power shedding battery end of discharge (EOD).

## 7. Specification

MODEL		1KVA(S)	2KVA(S)	3KVA(S)
PHASE		Single phase with ground		
Capacity (VA/Watts)		1000VA / 800W/900W/1000W	2000VA / 1600W/1800W/2000W	3000VA / 2400W/2700W/3000W
<b>INPUT</b>				
Nominal voltage		200/208/220/230/240VAC		
Operating voltage range (Ambient Temp. <40°C)	Low line transfer	176Vac±5% @ 100%-50% load; 110Vac±5% @ 50%-0% load;		
	Low line comeback	186Vac±5% @ 100%-50% load; 120Vac±5% @ 50%-0% load;		
	High line transfer	264Vac±5% @ 100%-50% load; 300Vac±5% @ 50%-0% load;		
	High line comeback	254Vac±5% @ 100%-50% load; 290Vac±5% @ 50%-0% load;		
Operating frequency range**		40-70Hz		
Power factor		0.99@100% load(Nominal Input Voltage)		
Bypass voltage range		<b>Bypass high voltage point</b> <b>230-264:</b> setting the high voltage point in LCD from 230Vac to 264Vac. (Default: 264Vac) <b>Bypass low voltage point</b> <b>176-220:</b> setting the low voltage point in LCD from 176Vac to 220Vac. (Default: 176Vac)		
Generator input		Support		
<b>OUTPUT</b>				
Output voltage*		200/208/220/230/240Vac		
Power factor		<b>0.8/0.9/1.0</b>		
Voltage regulation		±1%		
Frequency	Line Mode (synchronized range)	46-54Hz or 56-64Hz		
	Bat. Mode	<b>(50/60±0.1)Hz</b>		
Crest factor		3:1		
Harmonic distortion (THDv)		≤3% THD with linear load ≤5% THD with non-linear load		
Waveform		Pure Sinewave		
Transfer time	AC mode <-> Batt. mode	Zero		
	Inverter <-> bypass	4ms(Typical)		
Efficiency(up to)		89% (AC mode)	90% (AC mode)	91% (AC mode)
<b>BATTERY</b>				
Battery Type		12V9AH	12V9AH	12V9AH
Numbers		2   3	4   6	6   8

Backup time	Long run unit depends on the capacity of external batteries											
Typical recharge time (standard model)	4 hours recover to 90% capacity (typical)											
Charging voltage	27.4 ±1%	41.0 ±1%			54.7 ±1%	82.1 ±1%	54.7 ±1%	82.1 ±1%	82.1 ±1%	109.4 ±1 %	82.1 ±1%	109.4 ±1 %
Charge current(A)	1/2	6/12			1/2	6/12		1/2	1	6/12		
<b>SYSTEM FEATURES</b>												
Overload	Line Mode	105%~125%: UPS transfers to bypass after 1minute when the utility is normal; 125%~130%: UPS transfers to bypass after 30 seconds when the utility is normal; >130%: UPS transfers to bypass immediately when the utility is normal.										
	Batt. Mode	105%~125%: UPS shuts down after 1 minute; 125%~130%: UPS shuts down after 10 seconds; >130%: UPS shuts down immediately.										
Short Circuit	Hold Whole System											
Overheat	Line Mode: Switch to Bypass; Backup Mode: Shut down UPS immediately											
Low battery voltage	Alarm and Switch off											
EPO (optional)	Shut down UPS immediately											
Audible & Visual alarms	Line Failure, Battery Low, Overload, System Fault											
Communication interface	USB (or RS232), SNMP card (optional), Relay card (optional)											
<b>ENVIRONMENTAL</b>												
Operating temperature	0°C ~40°C											
Storage temperature	-25°C ~55°C											
Humidity range	20-90 % RH @ 0- 40°C (non-condensing)											
Altitude	< 1500m											
Noise level	Less than 55 dBA at 1 Meter											
<b>PHYSICAL</b>												
Dimension WxDxH (mm)	144 * 293 * 209	144 * 399 * 209	144 * 293 * 209			191* 460* 337						
Net Weight (kg)	9.1	12.2	4.1			19.5	24.5	10.3	24.5	32.8	10.9	



**POWER SOLID**

[WWW.POWERSOLID.VN](http://WWW.POWERSOLID.VN)