

Gold PRO Racing Lane Line - Official FINA Installation Instructions

According to rules (FR 2.6.1, FR 3.8)

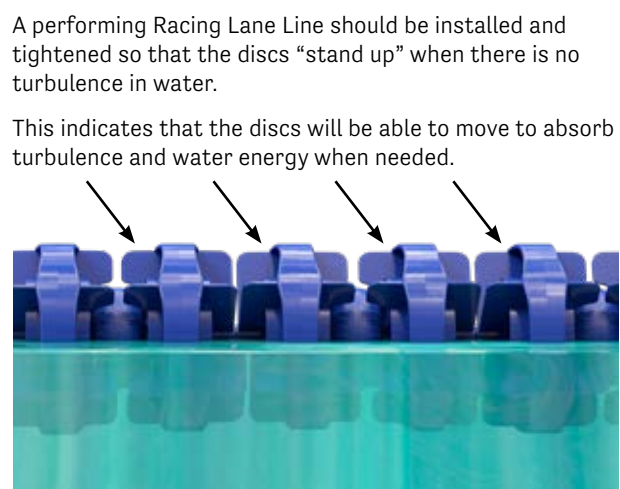
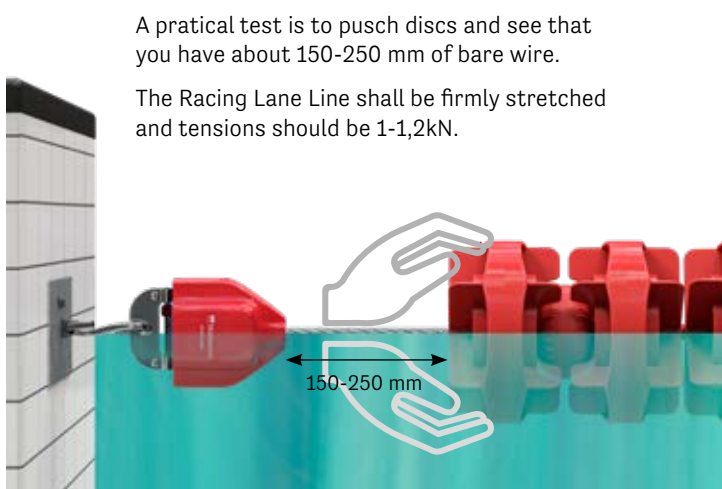
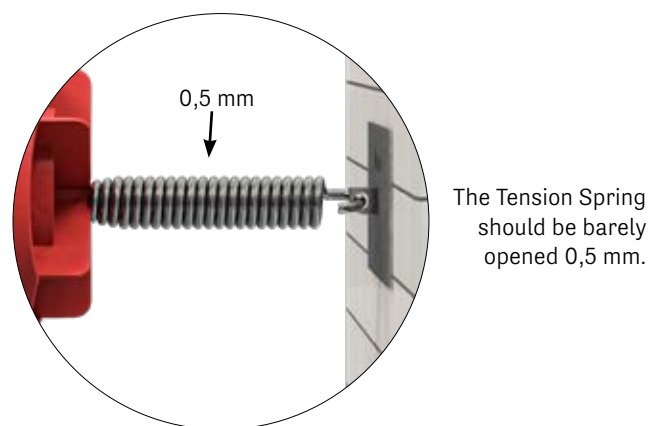
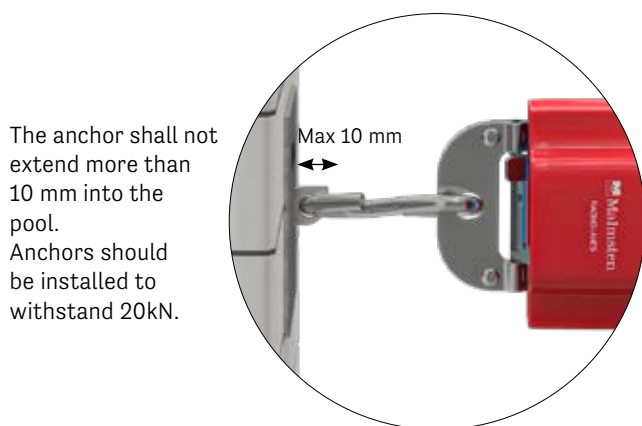
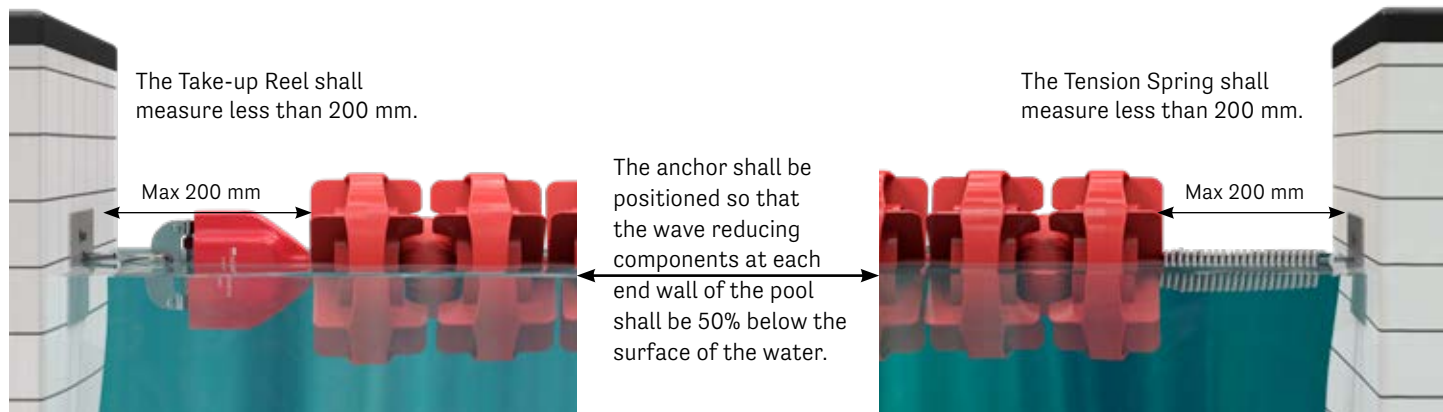

Handling Take-up Reel with the Original Ratchet Wrench

The Take-up Reel of the Racing Lane Line rope requires a tool to lock tensioning into position and to prevent non-authorized tampering. Use only Malmsten Ratchet Wrench to tighten lanes. For correct tension see the separate step-by-step installation instructions for Racing Lane Line.

Tightening lanes:

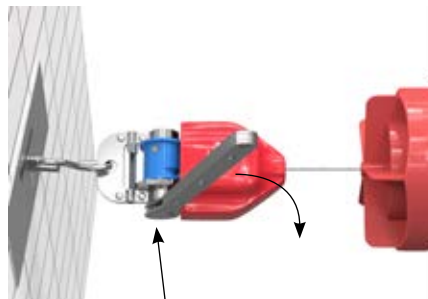

1. Wind cable on spool evenly with Malmsten Ratchet Wrench. Move the cylinder three notches at a time.

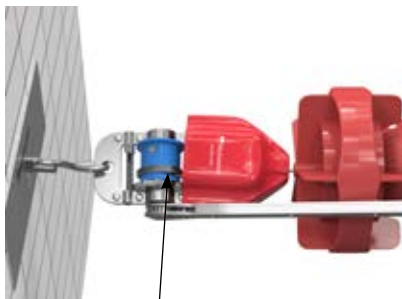

2. It is important not to overlap the cable.

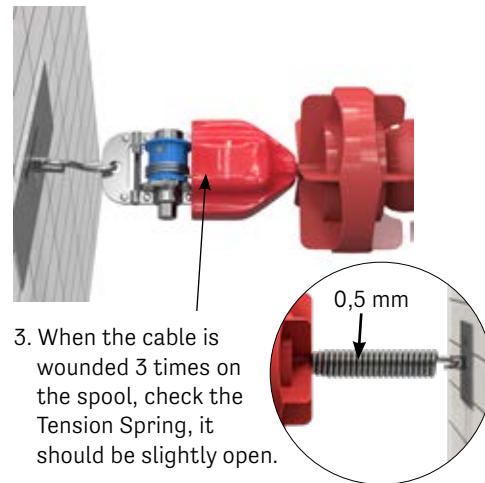

3. When the cable is wound 3 times on the spool, check the Tension Spring, it should be slightly open.

Distance:



According to rules (FR 2.6.1, FR 3.8)

The Take-up Reel shall measure less than 200 mm.

Realsing lanes:

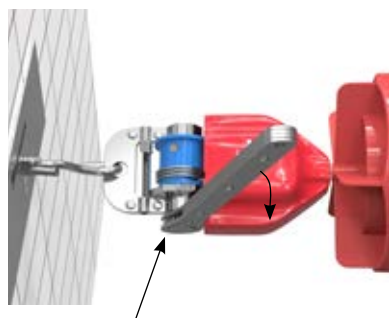

1. Use only Malmsten Ratchet Wrench to loosen lanes. Increase lane tension enough to release pressure on locking device.

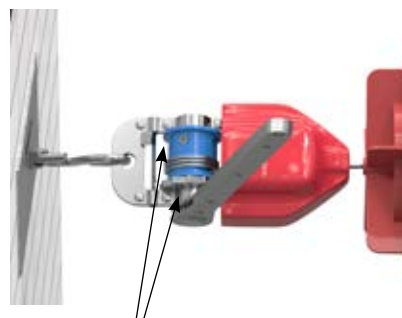

2. Depress thumb pawl on locking device and allow spool to release tension one notch.

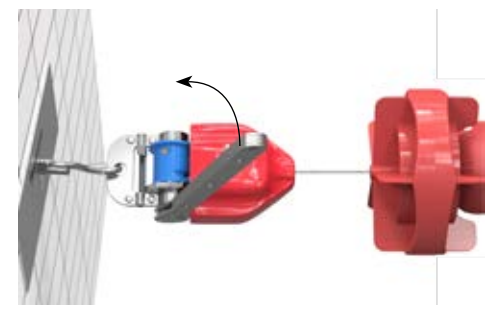

3. Repeat step 2 until tension is completely released by applying the Malmsten Ratchet Wrench and moving the cylinder three notches.

Warning:

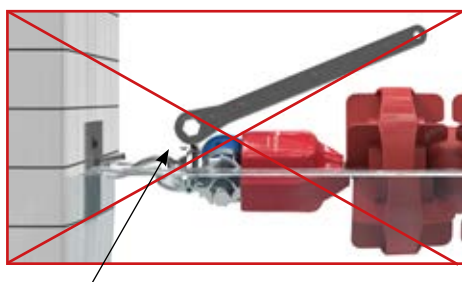

WARNING! When reel is under tension never hit thumb pawl with Ratchet Wrench to release catch lock.

DO NOT allow reel spool to run free. This will damage teeth on spool and cause backlash of wire. It is also dangerous for the operator.

Selected When it Counts

Take-up reel lane line with cover

Mounting instructions for replacement

The handling of the Take-Up reel should only be done with the Original Ratchet Wrench (always included with your purchase). Any other tool may damage the Take-Up reel.

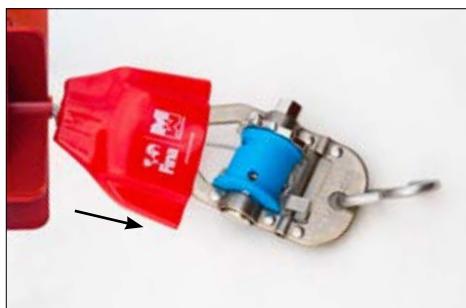
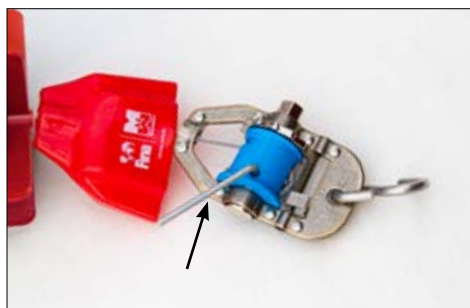
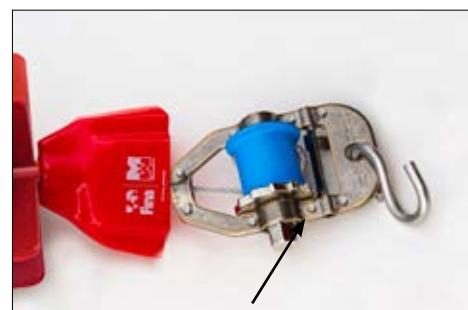
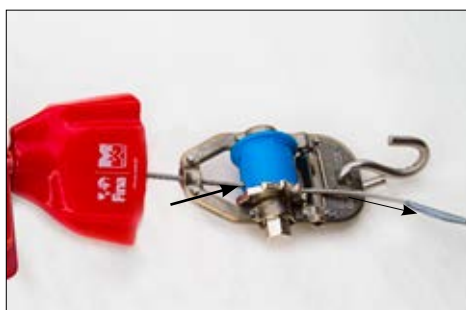
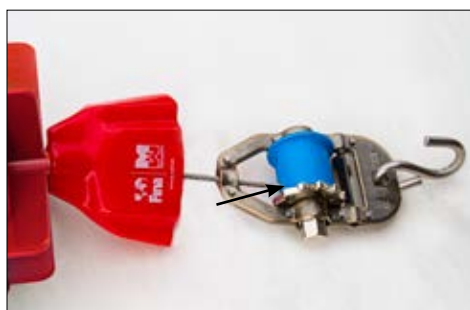
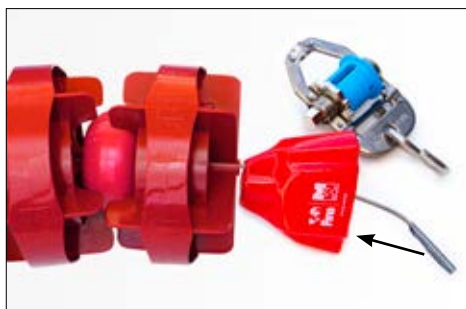
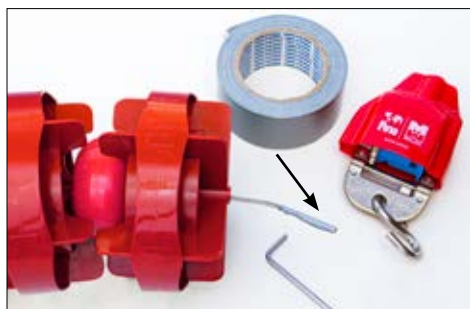

According to rules (FR 2.6.1, FR 3.8)

The Take-up Reel shall measure less than 200 mm.

Tension Spring for Lane Line

Mounting instructions for replacement

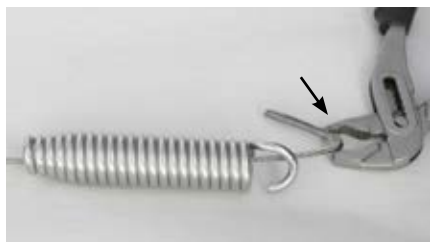

**According to rules
(FR 2.6.1, FR 3.8)**

The Take-up Reel shall measure less than 200 mm.

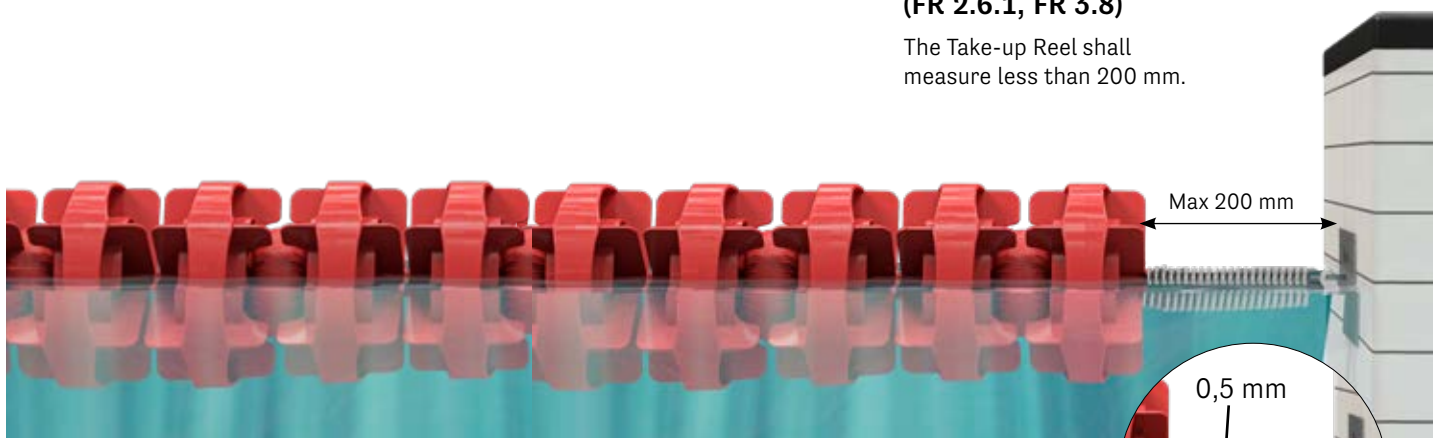

The Tension Spring should be barely opened 0,5 mm.

Selected When it Counts