

VERTO

50G519

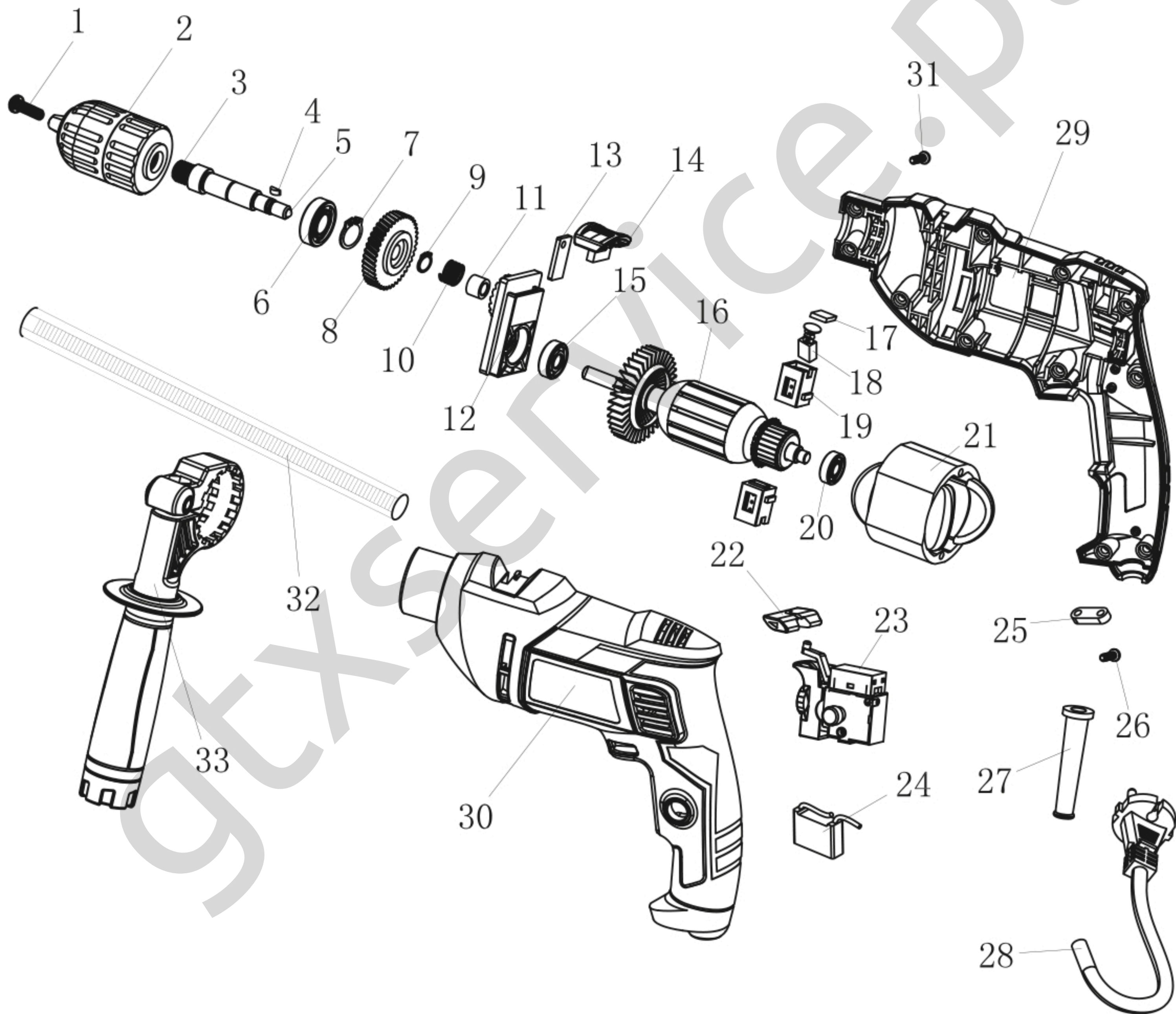

No	SKU	Net_Price_EUR	Net_Price_USD
1	K/SR5L20	0,57	0,63
2	K/58G708-16	8,38	9,33
3	K78458	4,38	4,88
4	K/59G093-183	0,95	1,06
5	K78458	4,38	4,88
6	K/LO6001	2,08	2,31
7			
8	K78459	3,43	3,82
9			
10			
11	K78460	4,38	4,88
12	K78460	4,38	4,88
13	K78461	3,43	3,82
14	K78461	3,43	3,82
15	k/LO608	2,08	1,80
16	K78462	8,38	9,33
17	K78463	2,29	2,54
18	K78464	2,29	2,54
19	K78463	2,29	2,54
20	K/LO607	2,08	1,75
21	K78465	5,72	6,36
22			
23	K78466	4,38	4,88
24			
25			
26			
27			
28	K/PZ22075	4,38	4,88
29			
30			
31			
32			
33			