

**Anschlüsse für
Entleerung/Entlüftung G 1/2"**
MS... Saugseite
MD... Druckseite

connections for
drain/ventilation plug G 1/2"
MS... suction side
MD... pressure side

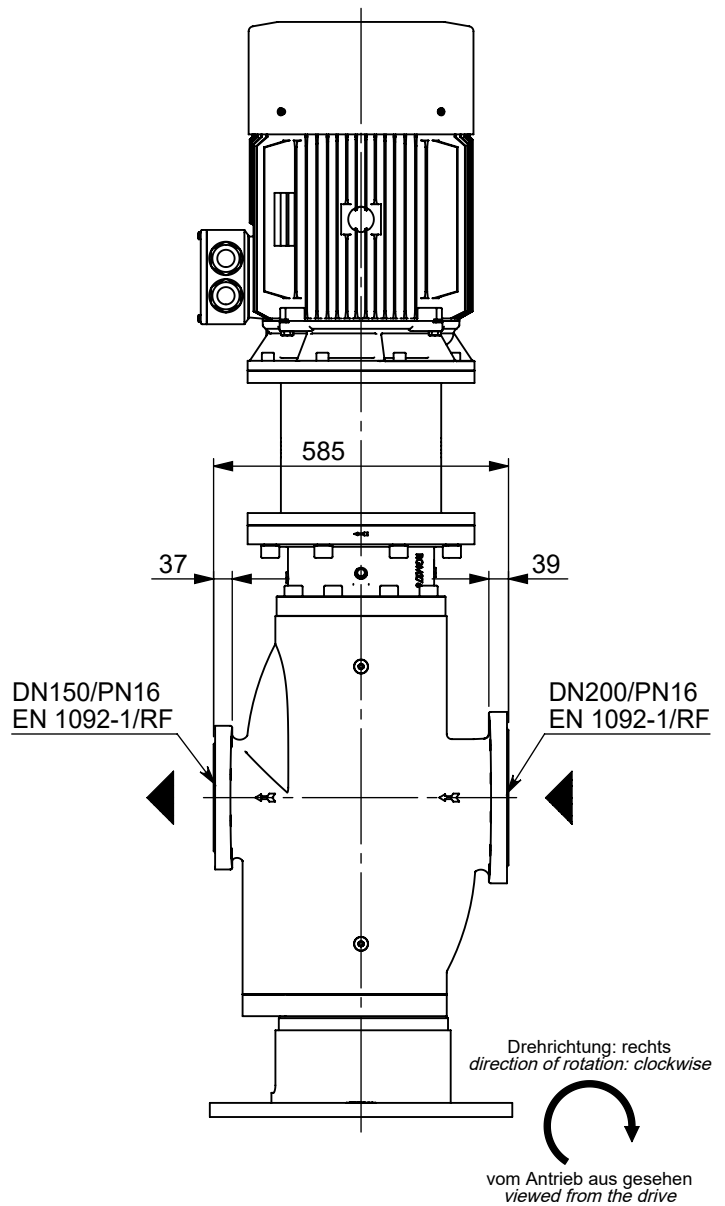
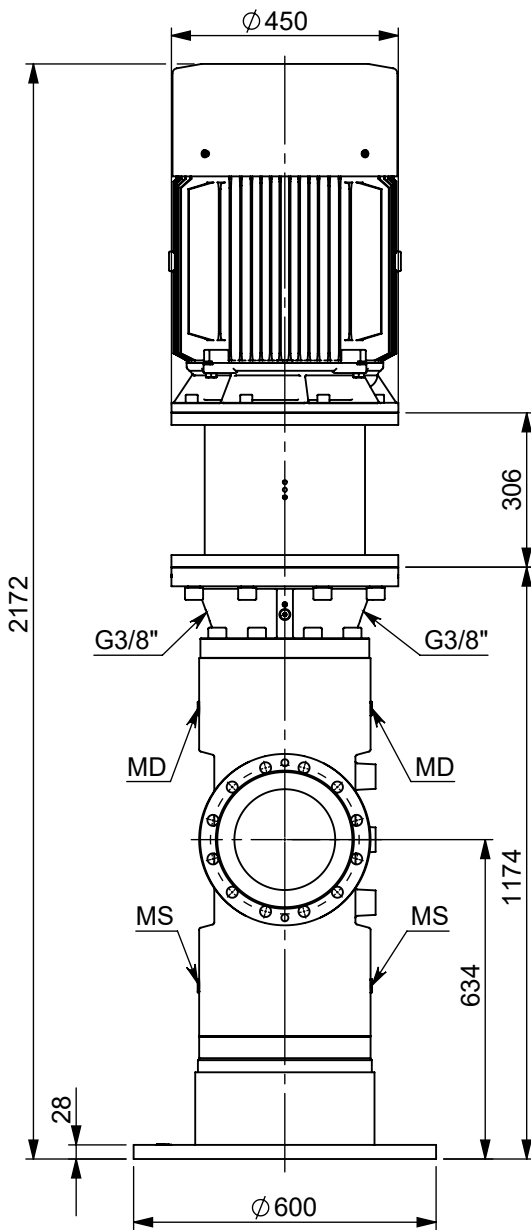
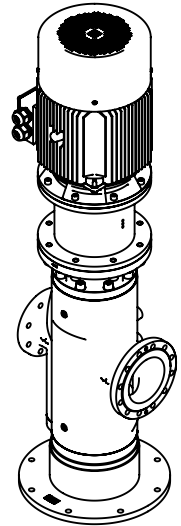

Maße ohne Toleranzangaben nach: Untoleranced dimensions: ISO 2768 - c EN ISO 13920 - B Baugruppe Schweißteil Assembly Welded part		Schraubenspindelpumpe / Pumpenstation Screw-pump / Pump-station KV-2500.ABA.100021 KV-2500+225-4/45		Datum: / Date: 01.12.2017	Erstellt: / Drawn: E. Kuster
				Datum: / Date: 01.12.2017	Geprüft: / Reviewed: N. Troppe
				Maßstab: / Scale: 1:15	Gewicht: / Weight: 983 [kg]
KRAL KRAL AG Bildgasse 40, Industrie Nord 6890 Lustenau, Austria www.kral.at		Schutzvermerk ISO 16016 beachten! Refer to protection notice ISO 16016! Alle Dimensionen in: All dimensions in:			TMP
		[mm] [mm]		A4 Blatt: / Sheet: 1 von: / of: 1	